



# Operator Manual

Cummins **Onan**

Performance you rely on.™



## Marine Generator Set

MDKBJ (Spec A)

## **California**

### **Proposition 65 Warning**

**Diesel engine exhaust and some of its constituents are known to the State of California to cause cancer, birth defects, and other reproductive harm.**



# Table of Contents

---

1. SAFETY PRECAUTIONS .....	1
1.1 Precaution Symbols .....	1
1.2 General Precautions .....	1
1.3 Generator Voltage Is Deadly .....	2
1.4 Engine Exhaust Is Deadly.....	2
1.5 Diesel Fuel is Combustible .....	3
1.6 Battery Gas is Explosive.....	3
1.7 Moving Parts Can Cause Severe Personal Injury Or Death .....	3
1.8 Flammable Vapor Can Cause A Diesel Engine To Overspeed.....	3
1.9 The Hazards of Carbon Monoxide.....	3
1.10 Substance Hazardous To Health.....	5
1.11 Generator Set Warning Labels .....	10
2. INTRODUCTION .....	13
2.1 About this Manual .....	13
2.2 How to Obtain Service .....	13
2.3 Noise.....	14
2.4 Electromagnetic Compatibility.....	14
2.5 Build Standards.....	14
3. CONTROL PANEL .....	17
3.1 Local Control Panel.....	17
3.2 Remote Control and Monitoring.....	18
4. CUMMINS ONAN DIGITAL DISPLAY .....	19
4.1 Turning On The Display .....	19
4.2 Start Button .....	19
4.3 Stop Button .....	19
4.4 Genset Status Screens.....	19
4.5 Fault Screens.....	21
4.6 Pre-Alarm Screens.....	23
4.7 Brightness and Contrast .....	24
4.8 Setup.....	25
4.9 Genset and Display Information .....	25
5. OPERATION .....	27

---

5.1 Fuel .....	27
5.2 Engine Coolant .....	27
5.3 Engine Oil .....	27
5.4 Batteries .....	28
5.5 Fire Extinguisher and Fire Extinguisher Port .....	28
5.6 Pre-Start Checks .....	29
5.7 Priming the Fuel System .....	30
5.8 Starting the Generator Set .....	30
5.9 Stopping the Generator Set .....	30
5.10 Stopping the Generator Set .....	31
5.11 Emergency Stop .....	31
5.12 Loading the Generator Set .....	31
5.13 No-Load Operation .....	32
5.14 Resetting Line Circuit Breakers .....	32
5.15 Connecting to Shore Power .....	33
5.16 Cold Temperature Operation .....	33
5.17 Care of New or Re-Built Engine .....	33
5.18 Exercising the Generator Set .....	34
5.19 Storing the Generator Set .....	34
6. PERIODIC MAINTENANCE .....	35
6.1 Periodic Maintenance Schedule .....	35
6.2 General Inspection .....	36
6.3 Maintaining the Battery and Battery Connections .....	37
6.4 Checking Engine Oil Level .....	38
6.5 Changing Engine Oil and Filter .....	38
6.6 Replacing Fuel Filters .....	39
6.7 Engine Cooling System .....	40
7. TROUBLESHOOTING .....	43
7.1 Overview .....	43
7.2 Troubleshooting with Status Lamp .....	43
8. SPECIFICATIONS .....	55
9. EMISSIONS .....	59
10. HOW TO OBTAIN SERVICE .....	61
10.1 Model Identification .....	61
10.2 In North America .....	61

---

---

10.3 Outside North America.....	62
11. MAINTENANCE RECORD .....	63

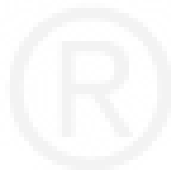



This page is intentionally blank.





# 1 Safety Precautions

---



-  **NOTE:** Thoroughly read the Operator manual before operating the generator set. Safe operation and top performance can only be obtained when equipment is operated and maintained properly.
-  **NOTE:** Only trained and experienced service personnel with knowledge of fuels, electricity, and machinery hazards shall remove, dismantle and dispose of the generator set. See service manual.
-  **NOTE:** Some generator set installation procedures present hazards that can result in severe personnel injury or death. Only trained and experienced personnel with knowledge of fuels, electricity, and machinery hazards should perform generator set installation procedures.

## 1.1 Precaution Symbols

The following symbols in this manual alert you to potential hazards to the operator, service person and equipment.

-  **DANGER:** *Used to alert you to a lethal hazard against which you must take steps to prevent severe personal injury or death, as when you are in the vicinity of High Voltage equipment.*
-  **WARNING:** *Used to alert you to a hazard or unsafe practice that can result in severe personal injury or death.*
-  **CAUTION:** *Used to alert you to a hazard or unsafe practice that can result in personal injury or equipment damage.*

## 1.2 General Precautions

-  **WARNING:** *Engine components can be hot and cause severe burns, liquid splash and lacerations of the skin. Use personal protective equipment when working with or around hazardous materials. Examples of personal protective equipment include (but are not limited to) safety glasses, protective gloves, hard hats, steel toed boots and protective clothing.*
-  **NOTE:** Generator set installation and operation must comply with all applicable local, state and federal codes and regulations. Only trained and experienced individuals should install or adjust the generator set.
- Keep children away from the generator set.
  - Do not use starting fluids that evaporate. They are highly explosive.
  - Do not step on the generator set when entering or leaving the generator room. Parts can bend or break leading to electrical shorts or to fuel, coolant or exhaust leaks.
  - To prevent accidental or remote starting while working on the generator set, disconnect the negative (-) battery cable at the battery. Hot, moving or electrically live parts can cause severe personal injury or death.
  - Let the engine cool down before removing the coolant pressure cap or opening the coolant drain. Hot coolant under pressure can spray and cause severe burns.

- Keep the generator set, drip pan and compartment clean. Oily rags can catch fire. Gear stowed in the compartment can restrict cooling.
- Make sure all fasteners are secure and properly torqued.
- Do not work on the generator set when mentally or physically fatigued or after having consumed alcohol or drugs.
- Used engine oil has been identified by some U. S. state and federal agencies as causing cancer or reproductive toxicity. Do not ingest, inhale, or contact used oil or its vapors.
- Ethylene glycol, used as engine coolant, is toxic to humans and animals. Clean up spills and dispose of used engine coolant in accordance with local environmental regulations.
- Keep multi-class fire extinguishers handy. Multi-purpose fire extinguishers are used for fires that involve ordinary combustible materials such as wood and cloth; combustible and flammable liquid fuels and gaseous fuels; live electrical equipment. (North America or US: Ref. NFPA No. 10)
- Use personal protective equipment when maintaining or installing the generator set such as gloves, safety glasses, etc.

### 1.3 Generator Voltage Is Deadly

Generator electrical output connections must be made by a trained and experienced electrician in accordance with applicable codes.



**WARNING:** *Interconnecting the generator set and shore power can lead to electrocution of utility line workers, equipment damage and fire. Use an approved switching device to prevent interconnections.*



**CAUTION:** *Use caution when working on live electrical equipment. Remove all jewelry, make sure clothing and shoes are dry, stand on a dry wooden platform or rubber insulating mat and use tools with insulated handles.*

### 1.4 Engine Exhaust Is Deadly

- Properly working carbon monoxide detectors must be located in all living/sleeping areas of the boat.
  - Never sleep in the boat while the generator set is running unless the boat is equipped with properly working marine carbon monoxide detectors.
- The exhaust system must be installed in accordance with the generator set Installation manual and be free of leaks.
- Make sure the bilge is adequately ventilated with a power exhauster/blowers.
- Inspect for exhaust leaks every startup and after every eight hours of operation.
- For more information about carbon monoxide see American Boat and Yacht Council (ABYC) publication TH-22—*Educational Information About Carbon Monoxide*.



## 1.5 Diesel Fuel is Combustible

- Do not smoke or turn electrical switches on or off where fuel fumes are present or in areas sharing ventilation with fuel tanks or equipment. Keep flames, sparks, pilot lights, arc-producing equipment and all other sources of ignition well away.
- Fuel lines must be secured, free of leaks and separated or shielded from electrical wiring.

## 1.6 Battery Gas is Explosive

- Wear splash-proof safety glasses.
- Do not smoke or permit flames or sparks to occur near the battery at any time.
- To reduce arcing when disconnecting or reconnecting battery cables, always disconnect the negative (-) battery cable first and reconnect it last.

## 1.7 Moving Parts Can Cause Severe Personal Injury Or Death

- Do not wear loose clothing or jewelry near moving parts such as PTO shafts, fans, belts and pulleys.
- Keep hands away from moving parts.
- Keep protective guards in place over fans, belts, pulleys, and other moving parts.

## 1.8 Flammable Vapor Can Cause A Diesel Engine To Overspeed



### **WARNING:**

**Do not operate a diesel-powered generator set where a flammable vapor environment can be created by fuel spill, leak, etc.**

Flammable vapor can cause a diesel engine to overspeed and become difficult to stop, resulting in possible fire, explosion, severe personal injury and death. The owners and operators of the generator set are solely responsible for operating the generator set safely.

## 1.9 The Hazards of Carbon Monoxide



**WARNING: Engine-driven generators can produce harmful levels of carbon monoxide that can injure or kill you.**

### 1.9.1 What Is Carbon Monoxide Poisoning?

Carbon Monoxide (CO) is an odorless, colorless, tasteless and non-irritating gas. You cannot see it or smell it. Exposure, even to low levels of CO, for a prolonged period can lead to asphyxiation (lack of Oxygen) resulting in death.

Mild effects of CO poisoning include:

- eye irritation
- dizziness
- headaches
- fatigue
- the inability to think clearly

More extreme symptoms include:

- vomiting
- seizures
- collapse

## 1.9.2 What Are The Special Risks of CO on Boats?

CO may accumulate in the following locations:

- between hulls
- under an overhanging deck
- under a rear swimming platform
- in and around the boat

A swimmer or passengers on deck and in the living quarters can be exposed to lethal levels of CO when the genset is running, especially when the boat is docked, beached or tied to a neighboring boat.

The risk of exposure to CO can be multiplied greatly by the "station wagon" effect, obstructions that block exhaust dissipation and infiltration from neighboring boats. To protect against all three situations, install reliable and approved marine CO detector alarms on your boat.



**WARNING: Carbon Monoxide (CO) gas can cause nausea, fainting or death.**

- **The Station Wagon Effect:** A boat pushes aside the air through which it is moving, causing a zone of low pressure in the back of the boat and cabins into which exhaust gases can be drawn (see the Station Wagon Effect - Boat Exhaust figure). A breeze across an anchored boat can have the same effect. Opening doors and windows so that air can flow through the boat can reduce the effect.

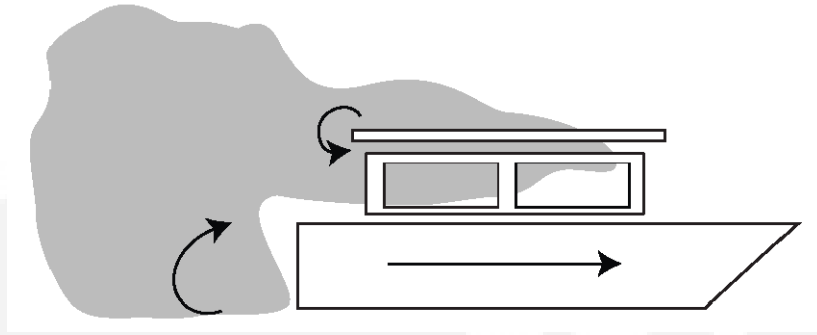

**FIGURE 1. STATION WAGON EFFECT - BOAT EXHAUST**

- **Obstructions:** Anchoring near a large object such as a boat house or sea wall or in a confined space such as a canyon can cause exhaust gases to accumulate in and around the boat despite good generator set maintenance and proper ventilation. Don't run the generator set when anchored in such places.
- **Exhaust from Neighboring Boats:** When boats are anchored in close quarters exhaust from neighboring boats can accumulate in and around yours.

### 1.9.3 Only You Can Protect Yourself From CO Poisoning!

- Watch constantly for swimmers when the generator set is running.
- Make sure exhaust cannot get under the deck, between hulls or enter the living quarters through a window, vent or door.
- Make sure all CO detectors are working properly.
- Pay attention to the signs of CO poisoning.
- Check the exhaust system for corrosion, obstruction and leaks each time you start the generator set and every eight hours if you run it continuously.

## 1.10 Substance Hazardous To Health

### 1.10.1 Substance Hazardous to Health

Generator sets use substances, and emit and create wastes that can cause health risks. Generator set operators must use appropriate personal protective equipment (such as clothing, gloves, protective glasses/goggles, and respiration equipment) when exposed to fuel, oil, coolant, wet batteries, grease, cleaning agents, or other substances exposed to lungs, eyes or skin. Use appropriate containers for transport, storage, and disposal of waste substances. Follow local regulations for disposal and recycling.

### 1.10.2 Antifreeze (Fleetguard - ES Compleat/EG Premix)

This antifreeze is also known as an ethylene glycol based coolant; summer coolant; coolant additive. It is purple colored, viscous liquid, with a mild chemical odor, is soluble in water and harmful. It contains ethylene glycol, and diethylene glycol. Ethylene glycol is a potentially hazardous constituent.

The substance has a boiling point of 107° C, and a flash point of 121° C.

It is used as an engine coolant additive, and can be found in engine cooling systems, and heat exchangers. Installers, operators and maintainers are likely to encounter this substance.

### 1.10.3 Hazardous Reactions

Ethylene glycol is combustible when exposed to heat or flame and can react vigorously with oxidants. Moderate explosive hazard in form of vapor when exposed to heat or flame. Hazardous products resulting from combustible or decomposition include carbon monoxide, carbon dioxide and acrid smoke. Self-contained breathing apparatus must be worn in the event of fume build up.

Avoid strong oxidizing agents - incompatible with sulfuric acid, nitric acid, caustics and aliphatic amines.

It may cause neurological signs and symptoms, and kidney damage. It is also a skin and eye irritant.

Very toxic in particulate form upon inhalation. Harmful if swallowed, lethal dose for humans reported to be 100ml.

### 1.10.4 Protective Measures

Refrain from eating, drinking or smoking when using the product. Adopt a high standard of personal hygiene. In case of skin contact, wash immediately with soap and water.

Ensure good ventilation and avoid heat sources. Avoid breathing mist, if there is a risk of vapor, or particulate, use a suitable organic vapor mask.

Eye protection, gloves, overalls, impervious apron should be used. Avoid contamination inside the gloves. If overalls become contaminated, discontinue use and clean thoroughly.

### 1.10.5 Storage/Transport

Store and transport only in correctly marked containers. Keep containers closed when not in use. Keep cool, out of sunlight and away from naked flames and strong acids, do not freeze. Store well away from food-stuffs and drinking water. Take special care to avoid discharge into drains, sewers and water-course.

Contain leak/spill with sand, earth or non-combustible, absorbent material to prevent entry of substance into drain/sewerage system, water-courses and land. Eliminate all ignition sources, use plastic shovel to transfer to suitable container and dispose of unwanted or absorbed substance through an authorized contractor to a licensed site.

### 1.10.6 Emergency Action

- Fire

Extinguishing media: CO<sub>2</sub>, alcohol resistant foam, dry powder, or water spray.

Fire fighters to use self contained breathing apparatus. Keep fire exposed containers cool. Prevent run-off from entering waterways, drains and drinking water supplies.

- Ingestion

Toxic by ingestion. If swallowed induce vomiting only under the advice of a Doctor or poison control center. Delayed treatment may result in fatality.

- Inhalation (of vapor)

Remove from further exposure. In case of irritation to lungs or throat, seek medical advice.

- Aspiration (inhalation of liquid)

Obtain immediate medical assistance.

- Eyes

Flush copiously with water or preferably eye-wash solution for at least five minutes. Seek medical advice.

- Skin

Wash thoroughly with soap and water, and seek medical attention if irritation develops. Change clothing if necessary and wash before re-use.

- Spillage

Soak-up using an absorbent material and dispose of this as directed under Storage/Transport.

### 1.10.7 Gas Oil

This product is also known as Red Diesel, Fuel Oil, and type A1 or A2. It can be pale red or clear liquid with a characteristic mild odor. It contains catalytically cracked oil, petroleum distillates, quinizarin, and gas oil maker dye red. The catalytically cracked oil and petroleum distillates are potentially hazardous constituents.

The substance has an initial boiling point of 180° C, and a flash point greater than 56° C, and a vapor pressure less than 0.7mm Hg at 20° C and has negligible solubility in water.

It is used as a fuel for off-road diesel powered vehicles and stationary engines, and can be found in fuel tanks, pipes and injection systems. The substance should not be used for any other purpose without contacting the manufacturer or supplier. Installers, operators and maintainers are likely to encounter this substance.

### 1.10.8 Hazardous Reactions

This liquid is flammable. Avoid smoking, heat sources, such as welding and naked flames, sparks and static electricity build-up. Thermal decomposition products are hazardous, containing CO<sub>x</sub>, NO<sub>x</sub> and SO<sub>x</sub> compounds.

The vapor is explosive. High vapor concentrations can cause respiratory irritation, dizziness, nausea, and loss of consciousness. Excessive and prolonged exposure to the mist can cause chronic inflammatory reaction of the lungs and a form of pulmonary fibrosis.

Avoid strong oxidizing agents, e.g. chlorates which may be use in agriculture.

Gas oil is slightly irritating to the skin and has a defatting action. Toxicity following single exposure to high level of gas oil is of low order. Prolonged, repeated skin contact may de-fat the skin resulting in possible skin irritation and dermatitis. In some cases warty, cancerous growths have occurred.

### 1.10.9 Protective Measures

Ensure good ventilation and avoid heat sources. Observance of good housekeeping rules will ensure general safety. Do not smoke. Avoid breathing mist.

When working on, or testing, injection equipment, special care is required to avoid perforation of skin by high pressure fuel. Use eye protection in the event of suspected high pressure leak.

Adopt a high standard of personal hygiene. In the case of skin contact, wash well with soap and water.

Use glove and overalls, and eye protection goggles if there is a risk of splashing. Use oil impervious gloves and avoid contamination inside the gloves. If overalls become contaminated, discontinue use and clean thoroughly. Contaminated clothing should be removed, soaked with water, and laundered before re-use.

No special respiratory precautions are necessary in normal use.

DO NOT use as a solvent for removing dirt/grease etc, from skin.

### 1.10.10 Storage/Transport

Store and transport only in correctly marked containers. Keep containers closed when not in use. Keep cool, out of sunlight and away from naked flames. Electrical continuity is required between the transport and storage vessels during product transfer.

Contain leak/spill with sand, earth or other suitable material, and prevent entry of substance into drainage/sewerage system, water-courses and land. Dispose of unwanted or absorbed substance through an authorized contractor to a licensed site.

Inform local and fire authorities should the product reach waterways, drains etc.

### 1.10.11 Emergency Action

- Fire

Extinguishing media:

Large fire - Foam/water fog. Never use water jet

Small fire - foam/dry powder, AAAF, CO<sub>2</sub>, sand, earth.

Avoid making sparks. Fire fighters to use self-contained breathing apparatus. Keep fire exposed containers cool, using water fog/spray. Prevent run-off from entering waterway, drains and drinking water supplies.

- Ingestion

Do not induce vomiting. Wash the mouth out with water, and send to hospital immediately.

- Inhalation (of vapor)

Remove from further exposure. Obtain medical assistance immediately.

- Aspiration (inhalation of liquid)

If, following ingestion of gas oil, vomiting occurs, there is danger of aspiration into the lungs. This would cause intense local irritation and chemical pneumonitis that can be fatal. Obtain immediate medical assistance.

- Eyes

Irrigate copiously with water or preferably eye-wash solution for at least five minutes. If irritation persists seek medical advice.

- Skin

Wash thoroughly with soap and water. Change clothing if necessary.

If high pressure injection has occurred prompt surgical attention is required.

- Spillage

---

Absorb using sand, earth or other suitable material. Dispose of unwanted or absorbed flammable material as directed under Storage/Transport.

### **1.10.12 Lubricant Oil - Premium Blue E 15W40**

Also known as oil, lube oil, sump oil, new oil is dark, viscous liquid with a slight, characteristic odor. The base oil contains: distillates (petroleum), solvent-dewaxed heavy paraffinic. It is not classified as dangerous according to Directive 1999/45/EC and its amendments, and is not classified according to the EU regulations.

It has a boiling point greater than 150°C, and a flash point Open Cup of 220°C (Cleveland), and is insoluble in cold water.

It is used in engine lubricant oil systems, sump pan and filters, make-up tanks and piping systems as a lubrication oil for use in wide range of diesel engines operating under severe conditions. Installers, operators and maintainers are likely to encounter this product.

### **1.10.13 Hazardous Reactions**

This product is stable although slightly re-active with oxidizing agents. Results of decomposition are carbon oxides (CO, CO<sub>2</sub>) and water.

Although harmful if swallowed or aspirated (breathed in), repeated or prolonged exposure is not known to aggravate medical conditions.

Used oil may contain harmful combustion by-products and unburnt fuel that will cause skin reactions as detailed for fuel. Particular care must be taken if oil from a severely overheated engine is handled-use impervious gloves, lab coat and safety glasses.

Do not breathe vapor/spray.

### **1.10.14 Protective Measures**

Ensure good ventilation and avoid heat sources.

Adopt a high standard of personal hygiene. In case of skin contact, wash thoroughly with soap and water.

Use safety glasses, impervious gloves and lab coat. Avoid contamination inside the gloves. If overalls become contaminated, discontinue use and clean thoroughly.

No special respiratory precautions are necessary in normal use. Do not breathe vapor/spray when handling hot materials.

### **1.10.15 Storage/Transport**

Store and transport only in correctly marked containers. Keep containers tightly sealed when not in use. Keep cool, well ventilated area, out of sunlight and away from naked flames. Store well away from food-stuffs and drinking water.

Wear splash goggles, full suit, boots and gloves. Absorb leak/spill with an inert material and dispose of unwanted or absorbed substance through an authorized contractor to a licensed site. Finish cleaning by spreading water on the contaminated surface and allow to evacuate through the sanitary system.

### **1.10.16 Emergency Action**

- Fire

Extinguishing media:

Large fire - Use water spray, fog or foam. Do not use water jet.

Small fire - Use dry chemical powder or CO<sub>2</sub>

Fire-fighters to use self contained breathing apparatus and full turnout gear. Keep fire exposed containers cool.

- Ingestion

Do not induce vomiting. Obtain medical advice immediately.

- Inhalation (of vapor)

Remove from further exposure. Obtain medical attention.

- Aspiration (inhalation of liquid)

Obtain immediate medical assistance.

- Eyes

Flush copiously with water or preferably eye-wash solution for at least fifteen minutes. Obtain medical advice.

- Skin



Wash thoroughly with soap and water. Obtain medical advice if irritation develops. Change clothing if necessary and wash before re-use.

- Spillage





Absorb with an inert material and dispose of this as directed under Storage/Transport.

## 1.11 Generator Set Warning Labels

Warning signs are provided on the generator set at or near the point of risk. To avoid injury, always take the necessary precautions - as indicated on the sample signs shown below:

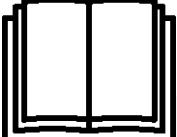
	Caution/Warning Indicates a risk of personal injury
	Caution/Warning of Temperature Hazard. Indicates a risk of personal injury from high temperature
	Caution/Warning of High Voltage Hazard. Indicates a risk of personal injury from electric shock/electrocution.

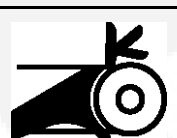

	<p>Caution/Warning of Engine Coolant Pressure Hazard. Indicates a risk of personal injury from hot pressurized engine coolant.</p>
	<p>Caution/Warning. Indicates to read Operator manual for additional information</p>
	<p>Caution/Warning of No Step. Indicates a risk of personal injury or equipment damage from stepping on equipment.</p>
	<p>Caution/Warning of Combustion/Explosion Hazard. Indicates a risk of personal injury from explosion.</p>
	<p>Caution/Warning of Belt and Rotating Part Hazard. Indicates a risk of personal injury from entanglement in moving parts.</p>
	<p>Caution/Warning of Chemical (ingestion/burn) Hazard. Indicates a risk of personal injury or asphyxiation from poisonous fumes or toxic gases.</p>
	<p>Caution/Warning of High Voltage or Current Source Hazard. Indicates a risk of personal injury from electrical shock/electrocution.</p>

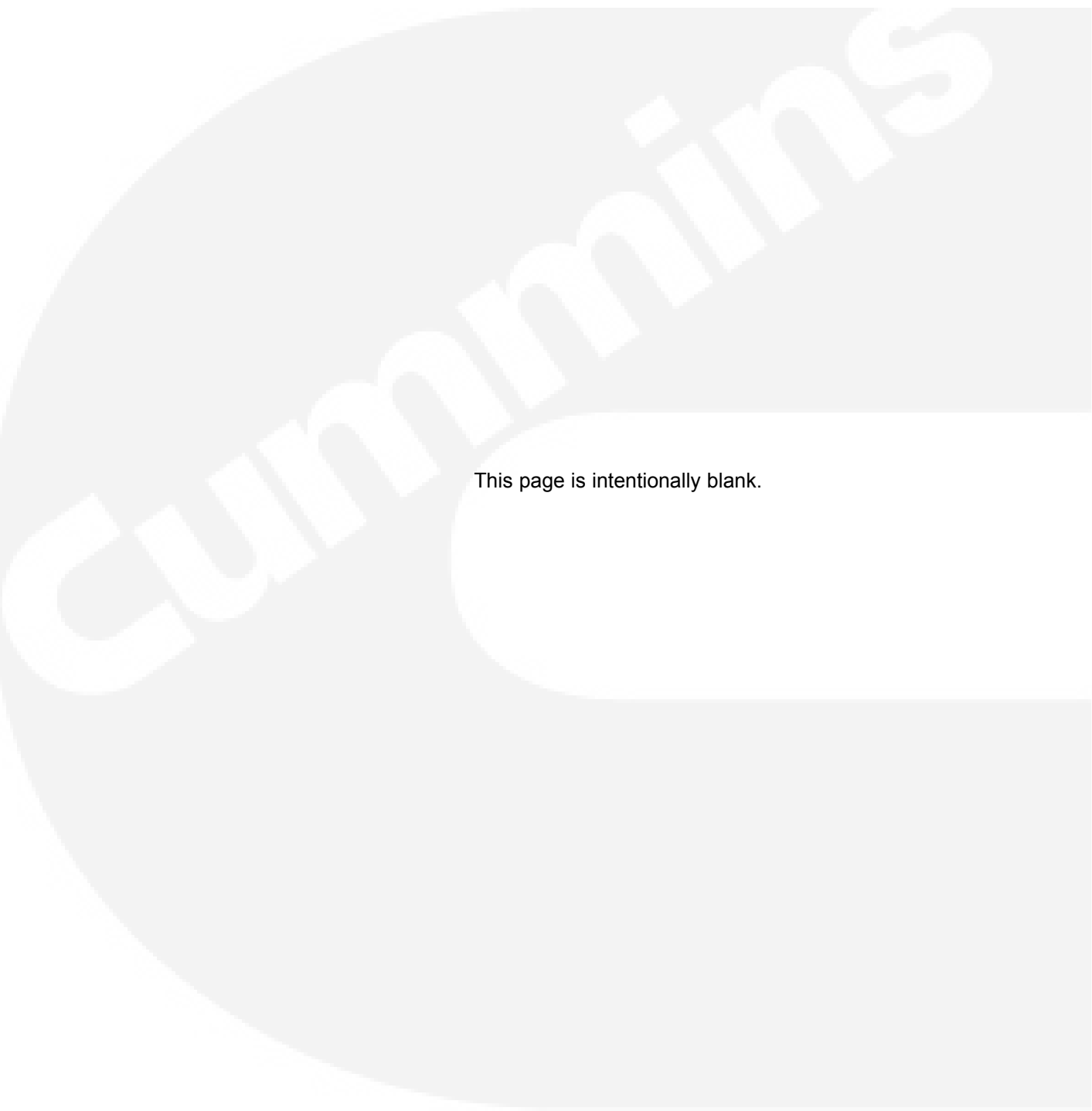

This page is intentionally blank.



# 2 Introduction

---

## 2.1 About this Manual

This is the Operator manual for the generator set(s) listed on the front cover. Each operator must study this manual carefully and observe all of its instructions and safety precautions. Keep this manual close at hand for reference.

The following chapters of this manual provide the instructions necessary for operating the generator set and maintaining it at top performance, as well as information that is needed to obtain service and to comply with emissions regulations.

- [Operation](#)
- [Periodic Maintenance](#)
- [Troubleshooting](#)
- [Specifications](#)
- [How to Obtain Service](#)
- [Emissions](#)

The owner is responsible for performing maintenance in accordance with the [Periodic Maintenance Schedule](#).



**WARNING:** *This generator set is not a life support system. It can stop without warning. Children, persons with physical or mental limitations, and pets could suffer personal injury or death. A personal attendant, redundant power or alarm system must be used if generator set operation is critical.*



**WARNING:** *This generator set is not "ignition protected" and shall not be used in flammable vapor environment.*



**WARNING:** *This generator set is not to be the main source of power for communication and steering systems. It can stop without warning.*

See the Parts manual for part identification numbers and required quantities.



**WARNING:** *Within the Parts manual, MC parts are MACHINE CRITICAL and must comply with boating safety ignition protection, backfire, fire resistance, exhaust system integrity, or other requirements established by regulatory agencies, such as the US Coast Guard, ABYC, and ISO. When MACHINE CRITICAL parts are replaced for any reason, use Onan parts that are identified with the part numbers in the appropriate Parts manual.*

## 2.2 How to Obtain Service

For generator set parts, service, and product information (such as the Service manual), contact the nearest authorized Cummins Onan distributor. You may go to Internet site [www.cumminsonan.com](http://www.cumminsonan.com) for information for contacting our distributors worldwide.

## 2.3 Noise

Generator sets emit noise. As noise level and time of exposure increase, risk of hearing damage increases. The Specifications page in the operator manual states noise level for this generator set. Select and use personal hearing protection appropriate for your exposure to generator set noise.

Note for use in countries where compliance to the EU Noise directive is required: This generator set has not been evaluated and is not marked for use in open air. Install the generator set in accordance with the installation manual. Obey local noise restrictions when you operate the generator set.

## 2.4 Electromagnetic Compatibility

Generator sets emit noise and receive electromagnetic (radio frequency) energy. If the generator set affects operation of nearby devices, or nearby devices affect generator set operation, increase the distance between them.

Note for use in countries where compliance to the EMC directive is required: This generator set has been evaluated for use in residential, commercial, and light industrial environments.

## 2.5 Build Standards

The generator set and its control system have been designed, constructed and tested generally in accordance with the following Standards where applicable.

BS EN 1037:1995+a1:2008	Safety of machinery - Prevention of unexpected start up.
BS EN ISO 14121-1:2007	Safety of machinery. Risk assessment Principles
BS EN ISO 13857:2008	Safety of machinery. Safety distances to prevent hazard zones being reached by upper and lower limbs.
BS EN 349:1993+A1:2008	Safety of machinery - Minimum gaps to avoid crushing parts on the human body.
BS EN 547-1:1996+A1:2008	Safety of machinery - Human body dimensions - Part 1: Principles for determining the dimensions required for openings for whole body access into machinery.
BS EN 547-2:1996+A1:2008	Safety of machinery - Human body dimensions - Part 2: Principles for determining the dimensions required for access openings.
BS EN 547-3:1996+A1:2008	Safety of machinery - Human body dimensions - Part 3: Anthropomorphic data.
BS EN 60204-1:2006+A1:2009	Safety of machinery. Electrical equipment of machines. General requirements.
BS EN 614-1:2006+A1:2009	Safety of machinery. Ergonomic design principles. Terminology and general principles.
BS EN 953:1997+A1:2009	Safety of machinery - Guards - General requirements for the design and construction of fixed and movable guards.
BS EN ISO 12100-1:2003+A1:2009	Safety of machinery. Basic concepts, general principles for design. Basic terminology, methodology
BS EN ISO 12100-2:2003+A1:2009	Safety of machinery. Basic concepts, general principles for design. Technical principles

BS EN ISO 13732-1:2008	Ergonomics of the thermal environment. Methods for the assessment of human responses to contact with surfaces. Hot surfaces
BS EN ISO 13849-1:2008	Safety of machinery - Safety-related parts of control systems
BS EN ISO 13850:2006	Safety of machinery - Emergency stop. Principles for design.
BS EN 61310-1:2008	Safety of machinery - Indication, marking and actuation - Part 1: Requirements for visual, auditory and tactile signals.
BS EN 61310-2:2008	Safety of machinery - Indication, marking and actuation - Part 2: Requirements for marking.
BS EN 61000-6-1:2007	Electromagnetic compatibility (EMC). Generic standards. Immunity standard for residential, commercial and light-industrial environments.
BS EN 61000-6-3:2007	Electromagnetic compatibility (EMC). Generic standards. Emission standard for residential, commercial and light-industrial environments.
BS EN 1299:1997+A1:2008	Mechanical vibration and shock - Vibration isolation of machines - Information for the application of source isolation
BS EN 1679-1:1998	Reciprocating internal combustion engines - Safety - Part 1: Compression ignition engines
BS EN 12601:2001	Reciprocating internal combustion engine driven generating sets - Safety



This page is intentionally blank.



# 3 Control Panel

## 3.1 Local Control Panel

The local control panel is shown below.

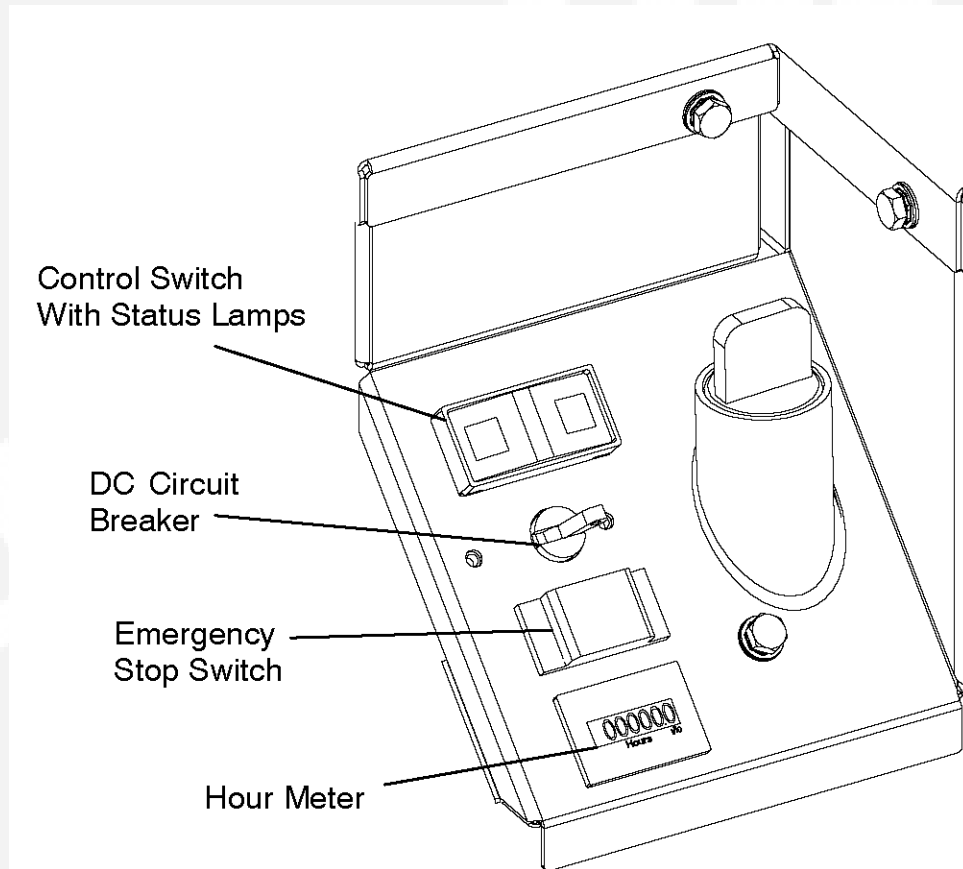

**FIGURE 2. LOCAL CONTROL PANEL**

The following sections describe the local control panel components.

### 3.1.1 Control Switch/Status Lamps (Standard)

The control switch is used to start and stop the generator set and prime fuel. It has two status lamps, green and amber.

- *Push and Hold* **START** to preheat, crank and start the generator set. The *Amber* status lamp flashes rapidly during cranking.
- *Push and Release* **STOP (Prime)** to stop the generator set.
- *Push and Hold* **STOP (Prime)** to prime the fuel system. (The *Amber* status lamp lights after 2 seconds and stays on while priming.)

- The *Amber* status lamp lights during fuel priming, flashes rapidly during cranking and goes out when the engine is up to speed. It also flashes the numeric fault code if the generator set shuts down abnormally. See the [Troubleshooting](#) section of this manual.
- The *Green* status lamp lights after starting and stays on while the generator set is running.

### 3.1.2 Emergency Stop Switch

In an emergency, push the switch **OFF**. Push it **ON** after all necessary repairs to the generator set and connected equipment have been made.

### 3.1.3 DC Circuit Breaker

The circuit breaker protects the DC control circuits of the generator set from short circuits. Reset after all necessary repairs have been made to the generator set.

### 3.1.4 Hour Meter

The hour meter records the accumulated number of hours of generator set operating time. It cannot be reset.

## 3.2 Remote Control and Monitoring

### 3.2.1 Remote Control Stations

The boat may be equipped with one or more remote control panels for generator set control and monitoring. A remote control panel consists of a control switch and status lamp.

### 3.2.2 Boat Monitoring System

Generator set operation may also be monitored by an integrated boat equipment monitoring system that uses SAE J1939 or SmartCraft™ network protocol. (SmartCraft is a trademark of the Brunswick Corporation.)

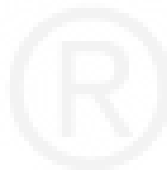



# 4 Cummins Onan Digital Display

---

The Cummins Onan Digital Display has an LCD panel with 4 navigation buttons, 3 LEDs, a **START** button, and a **STOP** button.

## 4.1 Turning On The Display

Touch any button to turn on the Cummins Onan Digital Display. The LCD back light will turn on.

- All connected Cummins Onan Digital Displays will turn on automatically when the genset is started at any station.
- They will all turn off 5 minutes after the genset shuts down.

## 4.2 Start Button



**WARNING:** Read and become familiar with the following sections, before pushing the **START** button:

- [Engine Exhaust Is Deadly](#)
- [Prestart Checks](#)
- [The Hazards of Carbon Monoxide](#)

Push and hold the **START** button until the blinking **GENSET** LED (green) stays on, indicating that the genset is producing AC voltage.



**NOTE:** Status on the **GEN STATUS** screen will change from *Starting* to *Running*.

## 4.3 Stop Button

**Stopping Genset:** Momentarily press the **STOP** button.

See the [Stopping The Genset](#) section for more information.



**NOTE:** Status on the **GEN STATUS** screen will change to *Stopped*.

**Priming Fuel System:** Press and hold the **STOP** button.



**NOTE:** Status on the **GEN STATUS** screen will display *Priming*.

## 4.4 Genset Status Screens

Genset status is displayed on multiple screens:

- GEN STATUS PG1 is shown when the display is turned on
- Press the double arrows to go to GEN STATUS PG2
- Press the double arrows again to go to GEN STATUS PG3
- Press the double arrows a third time to go to GEN STATUS PG1

The *Status* line will display one of the following words:

- Priming
- Starting
- Running
- Stopped

The status screens also display the following information:

- Engine coolant temperature
- Oil pressure
- Battery voltage
- Total genset running time



**NOTE:** The total time on the master hour meter on the genset control panel prevails if the total time on the Cummins Onan Digital Display is different.



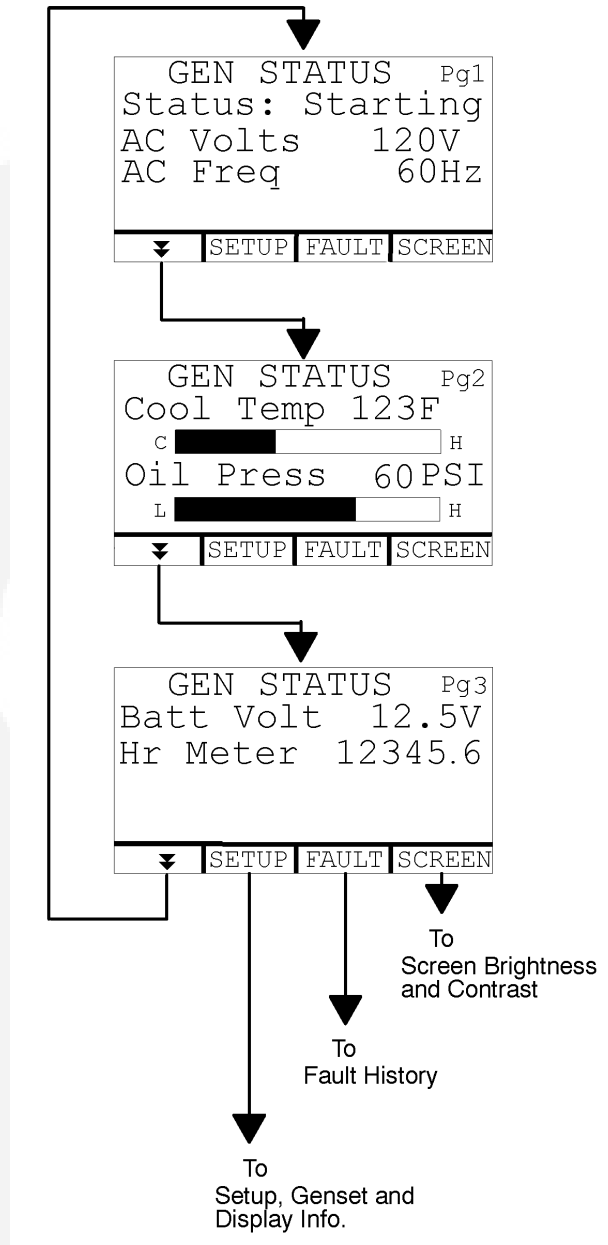

FIGURE 3. TYPICAL GENERATOR SET STATUS SCREENS

## 4.5 Fault Screens

### 4.5.1 Active Fault

When a fault occurs, the genset controller will cause the Cummins Onan Digital Display to flash the red ALARM LED and display the *Fault Number* and a brief description of the Fault.

- Find the corresponding Fault Number in the [Troubleshooting](#) section of this manual and follow the step-by-step procedures to correct the fault.

- The Cummins Onan Digital Display will display the fault indefinitely.
  - Touch any button to clear the fault. The display will turn off in 5 minutes after the fault has been cleared.
  - Press BACK to go back to the GEN STATUS screen.

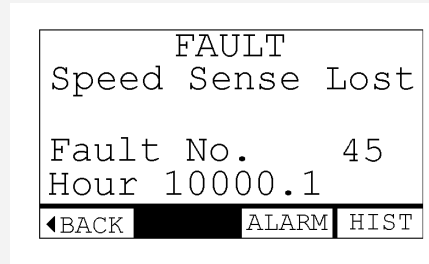

FIGURE 4. TYPICAL FAULT SCREEN

## 4.5.2 Last Fault

Touch any button again to turn on the Cummins Onan Digital Display.

- Press the FAULT button on the GEN STATUS screen to display the FAULT screen.
  - If there is an active fault, the FAULT screen will display the *Fault Number* and description of the fault.
  - If there is no active fault, the fault screen will display *No Active Fault*.

To display the LAST FAULT screen, press the LAST button on the FAULT screen.

- The LAST FAULT screen will display the *Fault Number* and description of the last Fault.
- Press BACK to go back to GEN STATUS.

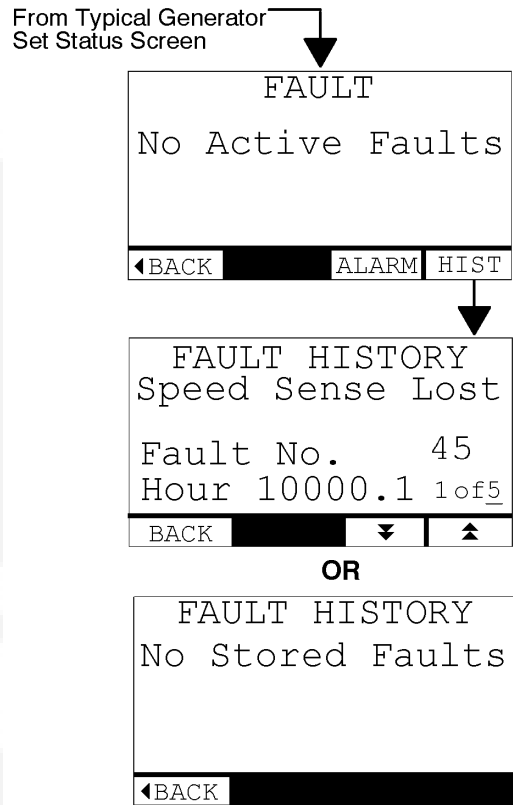

FIGURE 5. TYPICAL FAULT HISTORY SCREENS

## 4.6 Pre-Alarm Screens

When engine oil pressure or temperature reach set points near the limits where the control shuts down the genset, the Cummins Onan Digital Display will flash the amber PRE-ALARM LED and display *Low Oil Pressure* or *High Engine Temperature* on the PRE-ALARM screen.

- Press BACK to go back to GEN STATUS to monitor the engine temperature or oil pressure.
- Shut down the genset and perform the maintenance or service required to restore normal operation.

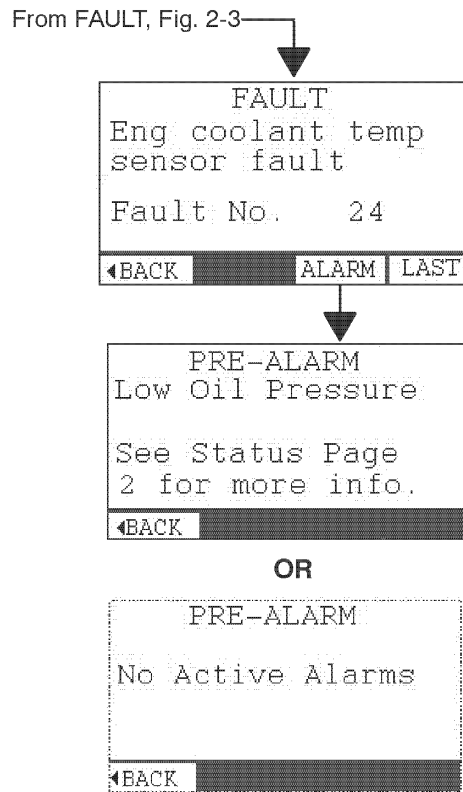

FIGURE 6. TYPICAL ENGINE PRE ALARMS SCREENS

## 4.7 Brightness and Contrast

To adjust the brightness and contrast of the LCD screen and LEDs:

1. Go to the SCREEN ADJUST screen by pressing SCREEN on any GEN STATUS screen.
2. Press NEXT to toggle between *Brightness* and *Contrast*.
3. Increase or decrease the selected item by pressing the increase-decrease buttons.
4. Press BACK to save the settings and go back to GEN STATUS.

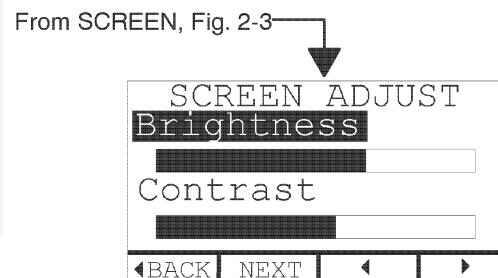

FIGURE 7. TYPICAL BRIGHTNESS AND CONTRAST SCREEN



## 4.8 Setup

To change the units of measure for engine temperature and pressure (GEN STATUS PG2):

1. Press the SETUP button.
2. Press the up/down arrows to toggle between SAE and METRIC units.
3. Press BACK to save the selection and go back to GEN STATUS.

## 4.9 Genset and Display Information

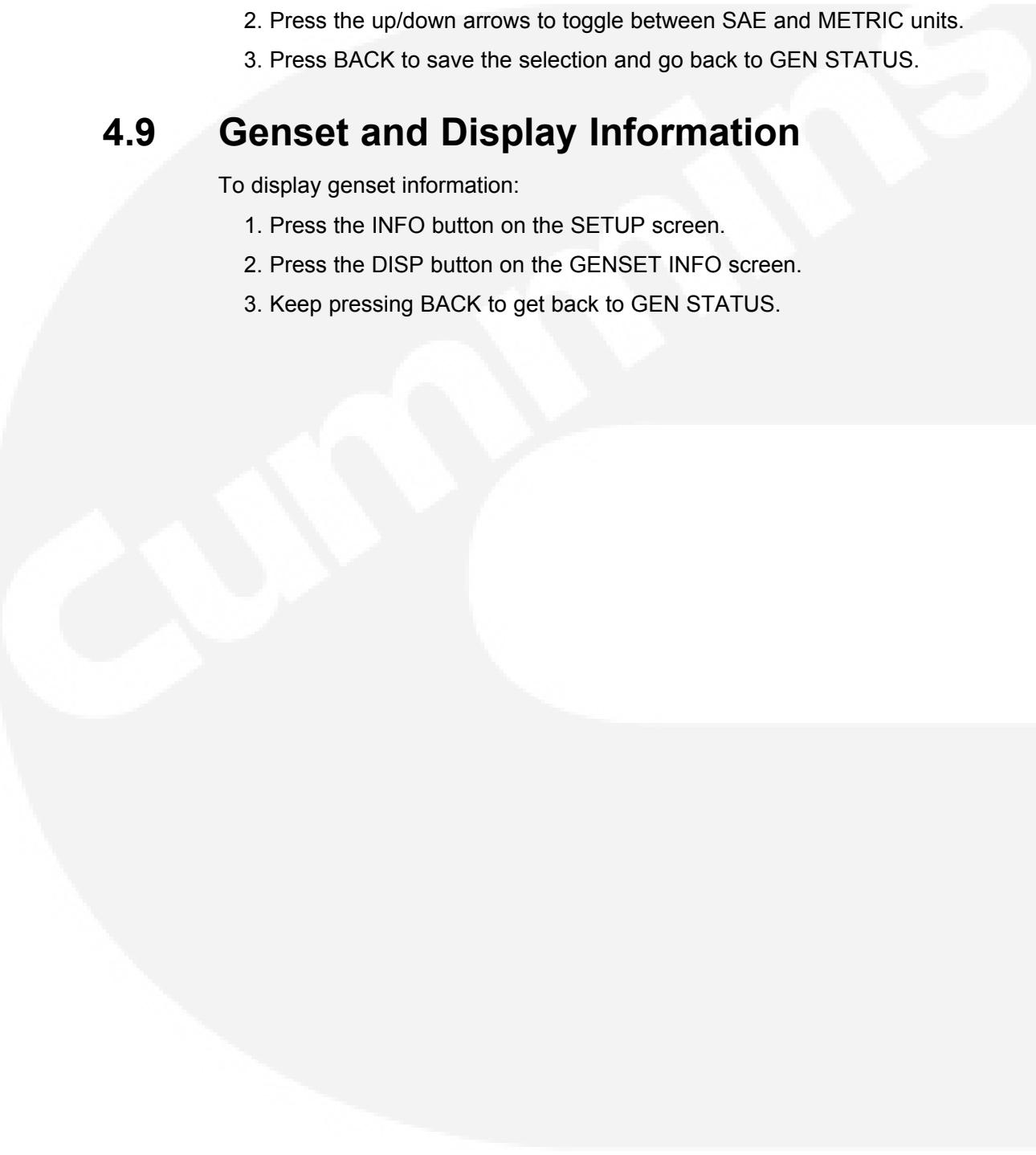
To display genset information:

1. Press the INFO button on the SETUP screen.
  2. Press the DISP button on the GENSET INFO screen.
  3. Keep pressing BACK to get back to GEN STATUS.
- 
- 

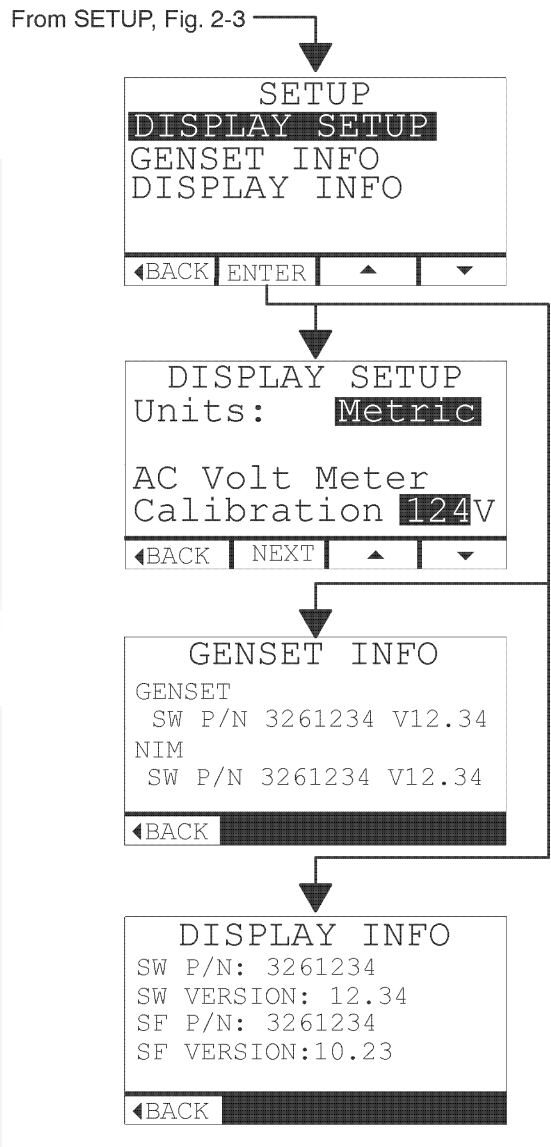

**FIGURE 8. TYPICAL SETUP SCREENS**



# 5 Operation

---

## 5.1 Fuel



**WARNING:** Diesel fuel is combustible and can cause severe personal injury or death. Do not smoke near fuel tanks or fuel-burning equipment or in areas sharing ventilation with such equipment. Keep flames, sparks, pilot flames, electrical arcs and switches and all other sources of ignition well away. Keep a multi-class ABC fire extinguisher handy.

High quality Grade 2-D diesel fuel is necessary for good performance and long engine life. Diesel fuels specified by EN 590 or ASTM D975 are recommended.



**NOTE:** Use Grade 1-D diesel fuel if the fuel tank is exposed to temperatures below 40° F (5° C).

- The Cetane number should not be less than 45 and sulfur content not more than 0.5% (by weight).
- Where fuel is exposed to cold ambient temperatures, use fuel that has a cloud point (temperature at which wax crystals begin to form) at least 10° F (6° C) below the lowest expected fuel temperature.
- Fuel lubricity should pass a minimum load level of 3100 grams as measured by ASTM D6078 or maximum scar diameter of 0.45 mm as measured by ASTM D6079 or ISO 12156-1.



**NOTE:** Ultra Low Sulfur Diesel (ULSD) fuel that meets the ASTM D975 standard for lubricity is suitable for use with this engine. The 1-2% less energy content of the fuel can have a slight effect on maximum engine power.



**NOTE:** B5 Bio-Diesel fuel that meets industry specifications and quality is suitable for use with this engine.

## 5.2 Engine Coolant

Use the best quality Ethylene Glycol antifreeze solution available. It should be fully formulated with rust inhibitors and coolant stabilizers.

- A 50/50 mixture of water and ethylene glycol is recommended to provide protection from freezing down to -34° F (-37° C).
- Use fresh water that is low in minerals and corrosive chemicals for the coolant mixture. Distilled water is best.

See the [Specifications](#) section regarding coolant capacity.



**WARNING:** Ethylene Glycol antifreeze is considered toxic. Dispose of it according to local regulations for hazardous substances.

## 5.3 Engine Oil

- Use API (American Petroleum Institute) Service Category **CI-4** engine oil or better.

- Also look for the SAE (Society of Automotive Engineers) viscosity grade. Choose the viscosity grade appropriate for the ambient temperatures expected until the next scheduled oil change (see Oil Viscosity Grade VS. Ambient Temperature chart below).
- Multi-grade oils such as SAE 15W-40 are recommended for year-round use.



**NOTE:** Dispose of oil in accordance with local regulations.

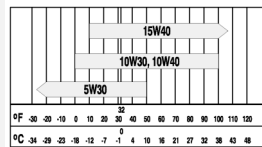

FIGURE 9. OIL VISCOSITY GRADE VS. AMBIENT TEMPERATURE

## 5.4 Batteries

Reliable generator set starting and starter service life depend upon adequate battery system capacity and maintenance. See [Maintaining the Battery and Battery Connections](#) and the [Specifications](#) section for more information.

## 5.5 Fire Extinguisher and Fire Extinguisher Port

The boat must have a fire extinguisher readily available for putting out a fire in the genset. It must be approved for liquid fuel and electrical equipment.

A generator set with an enclosure has a fire extinguisher port accessible by breaking through the circle on the warning label located as shown in the Fire Extinguisher Port figure below. The fire extinguisher must be of the gaseous type.



**CAUTION:** Make sure that the nozzle of the fire extinguisher that will be used in the event of a fire is smaller than the circle so that it will fit through the port.

In the event of fire:

1. DO NOT open the generator set enclosure.
2. Shut down engines, generators and blowers.
3. Break through the circle on the label with the nozzle and discharge the full contents of the fire extinguisher.

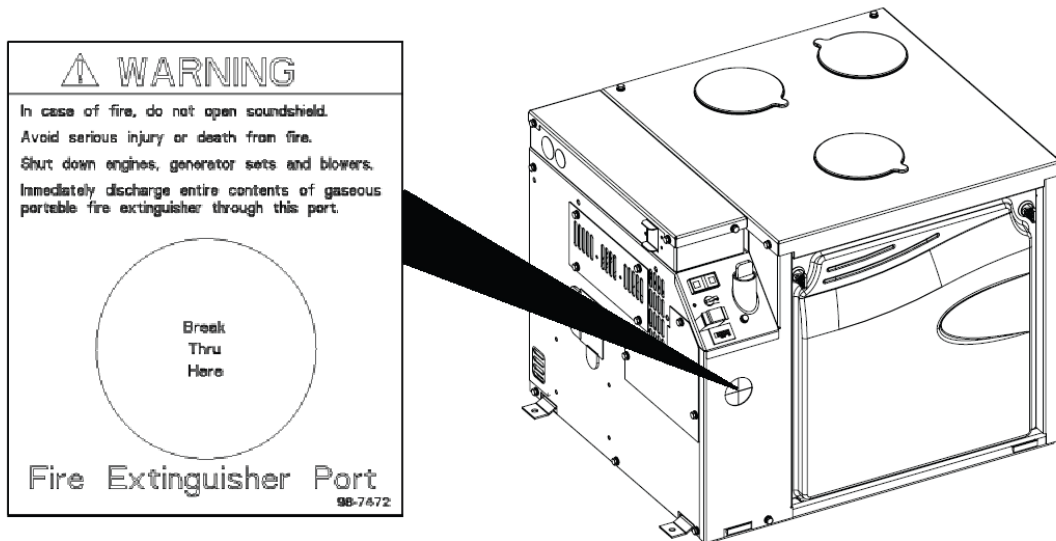

FIGURE 10. FIRE EXTINGUISHER PORT

## 5.6 Pre-Start Checks



**WARNING: EXHAUST GAS IS DEADLY.** All engine exhaust contains carbon monoxide; an odorless, colorless, poisonous gas that can cause unconsciousness and death. Symptoms of carbon monoxide poisoning include:

- Dizziness
- Headache
- Nausea
- Weakness and sleepiness
- Vomiting
- Inability to think coherently

**GET EVERYONE OUT INTO FRESH AIR IMMEDIATELY IF ANYONE EXPERIENCES ANY OF THESE SYMPTOMS.** Seek medical attention if symptoms persist. Never sleep in the boat when the generator set is running, unless the cabin has a working carbon monoxide detector.

**Look over the entire exhaust system and listen for leaks every time you start up the generator set and after every eight hours of operation. Shut down the generator set immediately if there is a leak. Do not run the generator set until the leak has been repaired. The exhaust system must be installed in accordance with the generator set Installation manual.**

Before the first start of the day and after every eight hours of operation, inspect the generator set as instructed under the [General Inspection](#) section. Keep a log of maintenance and the hours run and perform any maintenance that may be due. See the [Returning the Generator Set to Service](#) section if the boat has been in storage.

Before each start:

1. Make sure all CO detectors on board are working properly.
2. Check for swimmers that might be exposed to the engine exhaust.
3. Disconnect all electrical loads and disengage the PTO (if so equipped).

## 5.7 Priming the Fuel System

The fuel system should be primed after replacing the fuel filter or running the generator set out of fuel. To prime the fuel system, push and hold **STOP (Prime)** on the control switch for at least 30 seconds.

## 5.8 Starting the Generator Set

The generator set can be started and stopped from the generator set control panel or remote control panel.

1. Visually inspect for water, coolant, fuel and exhaust leaks by searching the generator set for residue from leaks. Repair fuel leaks immediately.
2. Push and hold **START** on the control switch until the generator set starts. The generator set status lamp blinks when the engine is cranking and comes on and stays on when the generator set starts and runs.
3. For longer engine life, let the engine warm up for two minutes before connecting air conditioners and other large electrical loads or engaging the PTO (if so equipped).



**CAUTION:** *Do not continue cranking and risk burning out the starter or flooding the engine (exhaust flow during cranking is too low to expel water from a wet exhaust system). Find out why the generator set does not start and make necessary repairs.*

4. **If the generator set fails to start**, cranking will discontinue in 20 to 60 seconds, depending on engine temperature. The control switch status lamp will indicate Fault Code No. 4. See the [Troubleshooting](#) section if the generator set does not start after several tries.
5. **If the generator set shuts down**, the control switch status lamp will indicate the numeric fault code. See the [Troubleshooting](#) section.

## 5.9 Stopping the Generator Set

Disconnect all electrical loads to let the generator set run without load and cool down. After 2 minutes push and release **STOP** on the control switch. The generator set status lamps will go out.

## 5.10 Stopping the Generator Set

Disconnect all electrical loads to let the generator set run without load and cool down. After 2 minutes push and release **STOP** on the control switch. The generator set status lamps will go out.



**CAUTION:** "After Boil" can force large amounts of coolant through the pressure cap and coolant recovery tank. Always let the engine cool down before stopping the generator set. Check for loss of coolant after every emergency stop or fault shutdown. Refill and clean up as necessary.

## 5.11 Emergency Stop

Push the EMERGENCY STOP SWITCH to **OFF**. After all necessary repairs have been made, push the switch to **ON** so that the generator set can be operated.

## 5.12 Loading the Generator Set

The power rating (KW) on the generator set nameplate determines how much electrical load (motors, fans, pumps, heaters, air conditioners, appliances, etc.) the generator set can power. The generator set will shut down or its line circuit breakers will trip if the sum of the concurrent electrical loads exceeds the generator set power rating.

To avoid shutdowns due to overloading the generator set:

- Compare the sum of the electrical loads that are likely to be used at the same time to the generator set power rating.
  - Use the electrical ratings on the nameplates of motors, fans, pumps and other such equipment.
  - Refer to the Typical Appliance Loads Table for typical appliance ratings.
  - If the equipment is marked in amps and volts only, multiply the amps times the volts to obtain the load in watts. Divide watts by 1000 to obtain load in terms of kilowatts (KW).



**NOTE:** It may be necessary to run fewer electrical loads and appliances at the same time, the sum of the loads must not be greater than the generator set power rating.

The generator set may shut down due to overloading when a large motor or air conditioner is started or cycles off and then on again, even though the sum of the electrical loads is less than the generator set power rating. The reason for this is that a motor's startup load is much greater than its running load.



**NOTE:** It may be necessary to run fewer electrical loads and appliances when large motors and air conditioners are cycling on and off.

The generator set is rated at standard barometric pressure, humidity and temperature (ref. ISO 3046). Either low barometric pressure (high altitude) or high ambient temperature will decrease engine power.



**NOTE:** It may be necessary to run fewer electrical loads and appliances when ambient temperatures are higher than normal.

**TABLE 1. TYPICAL APPLIANCE LOADS**

Appliance	Load (watts)
Air Conditioner	1400-2000
Battery Charger	Up to 3000
DC Converter	300-700
Refrigerator	600-1000
Microwave Oven	1000-1500
Electric Frying Pan or Wok	1000-1500
Electric Stove Element	350-1000
Electric Water Heater	1000-1500
Electric Iron	500-1200
Electric Hair Dryer	800-1500
Coffee Percolator	550-750
Television	200-600
Radio	50-200
Electric Drill	250-750
Electric Broom	200-500
Electric Blanket	50-200

### 5.13 No-Load Operation

**Keep no-load operation to a minimum.** During no-load operation cylinder temperatures drop to the point where fuel does not burn completely, causing fuel wetting and white smoke. It is best to run the generator set at 1/4 to 3/4 load.

### 5.14 Resetting Line Circuit Breakers

Connecting too many electrical loads and appliances can trip the line circuit breakers on the generator set or on the boat's power distribution panel.



**NOTE:** Note that the generator set will continue to run if its circuit breaker trips.

If a circuit breaker trips:

1. Disconnect or turn off as many electrical loads and appliances as possible.
2. Reset the circuit breaker.
3. Reconnect the loads and appliances one-by-one, making sure not to overload the generator set or cause a circuit breaker to trip.

An electrical load or appliance probably has a short if it trips a circuit breaker immediately when it is connected. Electrical equipment must be used and maintained properly and be properly grounded to cause the line circuit breakers to trip when short circuits occur.



**WARNING:** Short circuits in electrical equipment can cause fire and electrical shock leading to severe personal injury or death. Electrical equipment and its grounding must be maintained properly to protect against short circuits.

## 5.15 Connecting to Shore Power

When provisions have been made for connecting shore power, the boat must have an approved device to keep the generator set and shore power from being interconnected.



**WARNING:** Interconnecting the generator set and shore power can lead to electrocution of utility line workers, equipment damage and fire. Use an approved switching device to prevent interconnections.

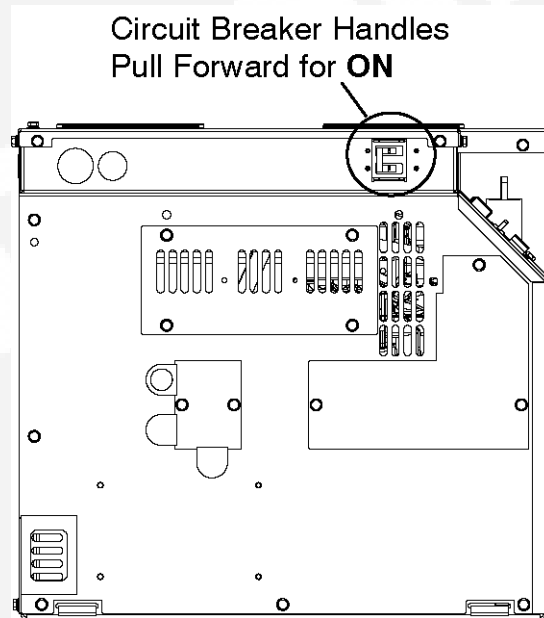

FIGURE 11. TYPICAL LINE CIRCUIT BREAKERS

## 5.16 Cold Temperature Operation

Drain the heat exchanger, muffler and fuel supply module before cold climates approach if the generator set is not being used. Freezing water can damage the muffler and the raw water tubes in the heat exchanger.

## 5.17 Care of New or Re-Built Engine

Avoid no-load operation as much as possible during break-in. Change the oil and oil filter after the first 50 hours of operation.

## 5.18 Exercising the Generator Set

Exercise the generator set at least 1 hour every month if use is infrequent. Run the generator set at 1/4 to 3/4 load. A single exercise period is better than several shorter periods. Exercising a generator set drives off moisture, re-lubricates the engine, uses up fuel before it becomes stale and removes oxides from electrical contacts. The result is better starting, more reliable operation and longer engine life.

## 5.19 Storing the Generator Set

Proper storage is essential for preserving top generator set performance and reliability when the generator set cannot be exercised regularly and will be idle for more than 120 days.

### 5.19.1 Storing the Generator Set

1. Turn off the generator set line circuit breaker.
2. Change the engine oil and filter and attach a tag indicating oil viscosity. See the [Engine Oil](#) section.
3. Crank the engine several revolutions by pressing the start switch momentarily, but do not let the engine start. This will fill the oil passages with the new oil.
4. Disconnect the battery cables (negative [-] cable first) from the starting battery and store the battery according to the battery manufacturer's recommendations. See the [Maintaining The Battery And Battery Connections](#) section.
5. Drain the heat exchanger and muffler if freezing temperatures are expected.
6. Clean and lightly oil parts that can rust.
7. Check coolant level and add as necessary. Test the coolant mixture if freezing temperatures are possible and change if necessary.



**WARNING:** *Hot coolant is under pressure and can cause severe burns when loosening the pressure cap. Let the engine cool before loosening the pressure cap.*

### 5.19.2 Returning the Generator Set to Service

1. Check the oil tag on the generator set and change the oil if the viscosity indicated is not appropriate for the temperatures expected. See the [Engine Oil](#) section.
2. Replace the raw water pump impeller if it is over one year old.
3. Perform the maintenance required.
4. Reconnect the starting battery (negative [-] cable last). See the [Maintaining the Battery and Battery Connections](#) section.
5. After connecting the battery conduct the pre-start checks and prime the fuel system.
6. Start and run the generator set.
7. Turn on the generator set line circuit breaker when ready to power loads.



# 6 Periodic Maintenance

## 6.1 Periodic Maintenance Schedule

Periodic maintenance is essential for top performance and long generator set life. Use the table below as a guide for normal periodic maintenance. To help you keep generator set maintenance regular and provide a basis for warranty claims, record maintenance performed in the [Maintenance Record](#) section of this manual.

Maintenance, replacement or repair of emission control devices and systems may be performed by any engine repair establishment or individual. However, warranty work must be completed by an authorized Cummins Onan service representative.



**WARNING:** To prevent accidental or remote starting while working on the generator set, disconnect the negative (-) battery cable at the battery. Hot, moving or electrically live parts can cause severe personal injury or death.

TABLE 2. PERIODIC MAINTENANCE SCHEDULE

Maintenance Operation	Maintenance Frequency								
	After First 80 Hrs	Every Day or 8 Hrs	Every Month or 100 Hrs	Every Year or 200 Hrs	Every Year or 350 Hrs	Every Year or 500 Hrs	Every 800 Hrs	Every 2 Years	Every 5 Years or 200 Hrs
General Inspection		X <sup>1</sup>							
Check Engine Oil Level		X							
Drain Water From Fuel Filter			X						
Inspect Battery and Battery Connections			X <sup>2</sup>						
Check V-Belt			X <sup>3</sup>						
Inspect Siphon Break			X						
Change Engine Oil and Oil Filter	X			X					
Replace Fuel Filters						X			
Replace Raw Water Impeller						X <sup>4</sup>			
Adjust Engine Valve Lash							X <sup>4</sup>		
Replace Coolant, Pressure Cap & Thermostat								X <sup>4</sup>	
Inspect Generator Bearing									X <sup>4</sup>

1 - Includes inspection of Oil Level, Coolant Level, Fuel System, Exhaust System, Batteries and Battery Connections.  
2 - See battery manufacturer's recommendations.  
3 - Check for slippage, cracking and wear.  
4 - Must be performed by a qualified mechanic (authorized Cummins Onan dealer).

## 6.2 General Inspection

Inspect the generator set before the first start of the day and after every eight hours of operation.

### 6.2.1 Oil Level

Check the engine oil level, by following the instructions in the [Checking Engine Oil Level](#) section.

### 6.2.2 Coolant Level

The recovery tank is designed to maintain coolant level, not to fill the system.

- Check coolant level in the recovery tank and, if necessary, refill the recovery tank to COLD when the engine is cold or to HOT when it is at normal running temperature.
- If the tank is empty, check for and repair any coolant leaks and refill the system through the fill neck on the engine.
  - Use the recommended antifreeze mixture.
  - See the [Refilling the Cooling System](#) section.

### 6.2.3 Exhaust System

Check that all CO monitors are working properly, and inspect the exhaust system for leaks and loose hose clamps at the:

- exhaust manifold
- exhaust elbow
- muffler
- water separator
- hull fittings

Replace any damaged sections of exhaust hose.



**WARNING: EXHAUST GAS IS DEADLY! Do not operate the generator set until all exhaust leaks have been repaired.**

## 6.2.4 Fuel System

- While the generator is stopped, check for leaks in the fuel supply at the:
  - hose
  - tube
  - pipe fittings
- Check the flexible fuel hose for:
  - cuts
  - cracks
  - abrasions
  - loose hose clamps
- Make sure fuel lines do not rub against other parts.
- Replace any worn or damaged fuel line parts before leaks occur.
  - Replace the hose with a high pressure fuel injection system USCG TYPE A1 or ISO 7840-A1 fuel hose.

Prime the fuel system if the generator set ran out of fuel.



**WARNING: Fuel leaks can lead to fire. Repair leaks immediately. Do not run the generator set if it causes fuel to leak.**

## 6.2.5 Raw Water System

Clean out the sea water strainer if necessary and make sure the sea valve is open for generator set operation. Also, when a water/exhaust separator is provided, open the sea valve for the water drain hose.

Check for and replace hoses that leak or are damaged.

## 6.2.6 Mechanical

- Look for mechanical damage and listen for unusual noises when the generator set is running.
- Check the generator set mounting bolts.
- Check to see that the generator set air inlet and outlet openings are not clogged with debris or blocked.
- Keep the generator set compartment clean.

## 6.3 Maintaining the Battery and Battery Connections

Refer to the [Periodic Maintenance Schedule](#) for scheduled battery maintenance and follow the battery manufacturer's instructions. Have the battery charging system serviced if DC system voltage is consistently low or high.

Check the battery terminals for clean, tight connections. Loose or corroded connections have high electrical resistance which makes starting harder.

Always:

1. Keep the battery case and terminals clean and dry and the terminals tight.
2. Remove battery cables with a battery terminal puller.
3. Make sure which terminal is positive (+) and which is negative (-) before making battery connections, always removing the negative (-) cable first and reconnecting it last to reduce arcing.



**WARNING:** *Arcing at battery terminals or in light switches or other equipment, and flames or sparks, can ignite battery gas causing severe personal injury.*

1. *Ventilate the battery area before working on or near battery*
2. *Wear safety glasses*
3. *Do not smoke*
4. *Switch the work light ON or OFF away from battery*
5. *Stop the generator set and disconnect charger before disconnecting battery cables*
6. *Disconnect negative (-) cable first and reconnect last*

## 6.4 Checking Engine Oil Level

Shut off the generator set and check the oil level with the dip stick. Add or drain oil as necessary. When the level falls to the ADD mark, add enough oil to bring the level up to the FULL mark. Drain oil if the level is above the full mark.

See the [Engine Oil Recommendations](#) section of this manual.



**WARNING:** *U.S. State and federal agencies have determined that contact with used engine oil can cause cancer or reproductive toxicity. Avoid skin contact and breathing of vapors. Use rubber gloves and wash exposed skin.*



**CAUTION:** *Too little oil can cause severe engine damage. Too much oil can cause high oil consumption.*

## 6.5 Changing Engine Oil and Filter



**WARNING:** *U.S. state and federal agencies have determined that contact with used engine oil can cause cancer or reproductive toxicity. Avoid skin contact and breathing of vapors. Use rubber gloves and wash exposed skin.*

Refer to the [Periodic Maintenance Schedule](#) for the engine oil change schedule.

1. Run the generator set under load until it is up to operating temperature, stop it and disconnect the negative (-) battery cable at the battery.



**WARNING:** *To prevent accidental or remote starting while working on the generator set, disconnect the negative (-) battery cable at the battery. Hot, moving or electrically live parts can cause severe personal injury or death.*



**WARNING:** *Engine components (drains, filters, hoses, etc) will be hot and can cause severe burns. The use of protective gloves is recommended.*

2. Remove the oil fill plug, open the front access door and drain the engine oil into a container by opening the drain valve.

1. The drain valve has a 3/8 NPT outlet for connecting a hose fitting to facilitate oil draining.



**NOTE:** If an oil pump-out system is installed, follow the instructions provided.

3. Close the oil drain valve.

4. Spin off the old oil filter and wipe off the filter mounting surface. (A filter wrench is available from Onan.) Remove the old gasket if it does not come off with the filter.

5. Apply a film of oil to the new filter gasket. Spin the filter on by hand until the gasket just touches the mounting pad and tighten 3/4 turn.

6. Refill the engine with the proper type and amount of engine oil. See the [Engine Oil](#) section. Check the oil level and add or drain oil as necessary. Run the engine for a few minutes, shut it down and recheck for proper oil level.



**NOTE:** Fill the oil slowly to prevent spillage.

7. Close the front access door and reconnect the battery cables (negative[-] last).

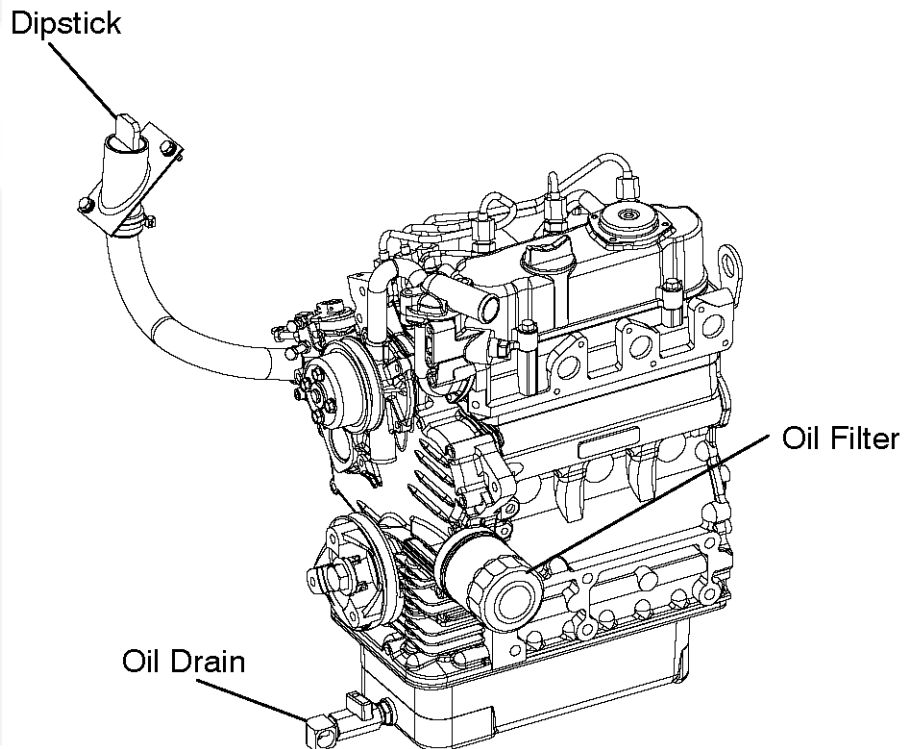

8. Dispose of the used oil and oil filter in accordance with local environmental regulations.



**FIGURE 12. OIL AND FUEL SERVICE POINTS**

## 6.6 Replacing Fuel Filters

Keep dirt, water and other contaminants from entering the fuel system and corroding or clogging fuel injection components.

-  **WARNING:** Fuel is combustible and can cause severe personal injury or death. Do not smoke near fuel tanks or fuel-burning equipment or in areas sharing ventilation with such equipment. Keep flames, sparks, pilot flames, electrical arcs and switches and all other sources of ignition well away. Keep a multi-class fire extinguisher handy.
-  **WARNING:** Accidental or remote starting can cause severe personal injury or death. Disconnect the negative (-) cable at the battery to prevent the engine from starting.
-  **WARNING:** Engine components (drains, filters, hoses, etc) will be hot and can cause severe burns. The use of protective gloves is recommended.

See the [Periodic Maintenance Schedule](#) for scheduled fuel filter replacement. Replace fuel filters if the engine lacks power.

1. Disconnect the negative (-) cable at the battery to prevent the engine from starting and close any fuel supply valves.
2. Remove the old filter and dispose of it in accordance with local environmental regulations.
3. Install the new filter.
4. Prime the engine. Run the generator set and check for leaks.

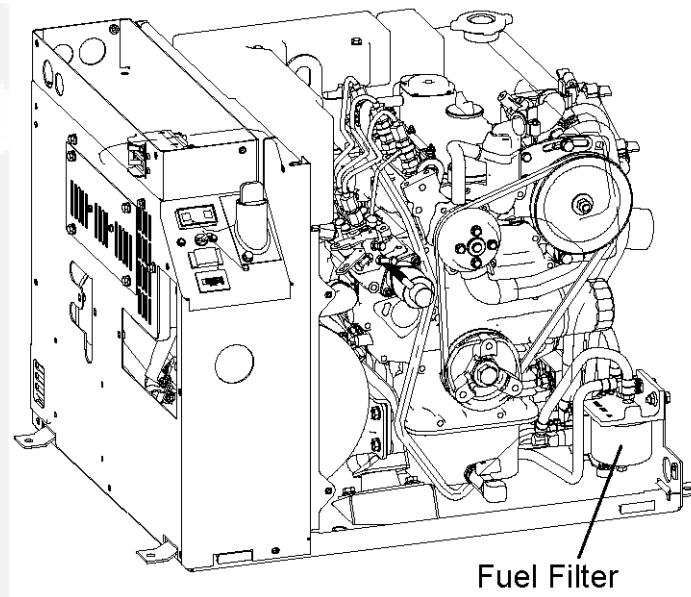

FIGURE 13. FUEL FILTER LOCATION

## 6.7 Engine Cooling System

### 6.7.1 Cooling System Overview

The engine is cooled by a pressurized, closed-loop liquid cooling system. Coolant is pumped through passages in the engine block, head and exhaust manifold. The exhaust manifold also serves as the engine coolant reservoir.

The heat exchanger is mounted inside the exhaust manifold. Raw water (the flotation water) is pumped through tubes in the heat exchanger to cool the engine coolant. The raw water then passes through a hose into the exhaust-water mixer where it cools the exhaust gases and is expelled. The V-belt drives the coolant and the raw water pumps.

### 6.7.1.1 Heat Exchanger

Raw water (the floatation water) is pumped through tubes in the heat exchanger to cool the engine coolant. The water is then passed through a hose into the exhaust-water mixer to cool the exhaust gases. The raw water is expelled from the boat along with the exhaust gases.

### 6.7.2 Recommended Coolant Mixture

Use the best quality ethylene glycol antifreeze solution available. It should be fully formulated with rust inhibitors and coolant stabilizers. Use fresh water that is low in minerals and corrosive chemicals. Distilled water is best. Unless prohibited by shipping regulations, the genset is shipped with the recommended 50/50 mixture of water/ethylene glycol, which is good for -34° F (-37° C). In warmer climates and sea water environments a 60/40 mixture of water/ethylene glycol is recommended. Coolant capacity is 3.3 quarts (3.1 liters).



**WARNING:** *Ethylene glycol antifreeze is considered toxic. Dispose of it according to local regulations for hazardous substances.*

### 6.7.3 Replenishing Normal Coolant Loss



**WARNING:** *Let the engine cool down before removing the coolant pressure cap or opening the coolant drain. Hot coolant under pressure can spray and cause severe burns.*

The recovery tank is designed to maintain coolant level; not to fill the system.

- Keep the level of coolant in the recovery tank between COLD and HOT.
- If the tank is empty:
  - Check for and repair any coolant leaks and refill the system through the fill neck on the engine.
  - Refill the recovery tank up to the COLD mark. Use the recommended mixture of antifreeze.
- Make sure the two hoses from the recovery tank are routed through the two holes in the right side of the genset enclosure, that the coolant recovery hose is connected to the fill neck on the engine
- Make sure that the overflow hose terminates in the drip pan where it will not splash coolant on electrical components.

### 6.7.4 Pressure Cap



**WARNING:** *Let the engine cool down before removing the coolant pressure cap or opening the coolant drain. Hot coolant under pressure can spray and cause severe burns.*

Replace the pressure cap every two years (seals deteriorate and leak). Proper cooling system pressure (7 psi) is essential for optimal engine cooling and minimal coolant loss.

## 6.7.5 Coolant Hoses



**WARNING:** *Engine components (drains, filters, hoses, etc) will be hot and can cause severe burns. The use of protective gloves is recommended.*

Check for and replace hoses that leak or are damaged. Have a qualified service person replace and leaking or damaged hoses.

## 6.7.6 Siphon Break

See the Periodic Maintenance Schedule for scheduled maintenance. A siphon break is installed when the exhaust-water mixer is below the water line. On a spring-loaded valve design, check for free movement of the plunger. Replace the device if the plunger does not move freely or the body is encrusted with deposits from leakage past the valve seat. If of the bleed-vent type, check that the vent hose is properly connected on both ends. If the vent is connected to a through-hull fitting, check for normal water flow whenever the engine is running. See the Installation Manual for more information regarding siphon break installation.



**WARNING:** *Bypassing a siphon break or failing to maintain it can lead to engine flooding and damage to the engine not covered under Warranty.*

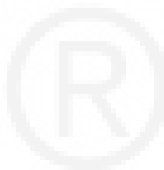



# 7 Troubleshooting

---

## 7.1 Overview

Use the blinking control switch status lamp to troubleshoot the generator set and perform the step-by-step corrective actions suggested in this section. If you are still unable to resolve the problem, contact an authorized Cummins Onan service representative. See the [How to Obtain Service](#) section of this manual.



**NOTE:** Many generator set shutdowns can be avoided by performing periodic maintenance on schedule and by *not* running the generator set out of fuel. Note that when generator sets and propulsion engines draw from the same fuel tanks, the fuel pickup tubes are usually arranged so that the generator sets run out of fuel first. By marking the generator set empty points on the fuel gauges, it will be easier to tell when to stop the generator sets before running them out of fuel.



**WARNING:** *Some generator set service procedures present hazards that can result in severe personal injury or death. Only trained and experienced service personnel with knowledge of fuels, electricity, and machinery hazards should perform generator set service. See the Safety Precautions section of this manual.*



**WARNING:** *Accidental or remote starting can cause severe personal injury or death. Before removing a panel or access door, disconnect the negative (-) cable from the battery to prevent the engine from starting.*

## 7.2 Troubleshooting with Status Lamp

If a fault shutdown occurs, the amber status lamp on the control switch will repeatedly blink sets of 3, 4, 5 or 7 blinks.

- **One blink** indicates shutdown due to high engine temperature.
- **Two blinks** indicate shutdown due to low oil pressure.
- **Three blinks** indicate a service fault. Press **Stop** once to cause the two-digit shutdown code to blink. (Pressing **Stop** again will stop the blinking.) The two-digit code consists of 1 to 7 blinks, a brief pause, and then 1 to 9 blinks. The first set of blinks represents the tens digit and the second set of blinks the units digit of the shutdown code number. For example, **Low Voltage Code No. 13** appears as: **blink—pause—blink-blink-blink—long pause—repeat**
- **Four blinks** indicate shutdown due to a failure to start within the time allowed for cranking.
- **Five blinks** indicate shutdown due to high levels of Carbon Monoxide (CO) in the vessel.
- **Seven blinks** indicate shutdown due to a loss of raw water flow for engine and exhaust cooling.

Blinking continues for five minutes and stops. To restore blinking press the control switch to **STOP (Prime)** until the lamp comes on (3 to 4 seconds). Then press **STOP (Prime)** three times to restores blinking.



**NOTE:** The last fault logged will blink even though the condition that caused the shutdown may have been corrected.

---

**NO RESPONSE AT THE CONTROL SWITCH****Possible Cause**

Faulty switch, poor or missing connections, dead battery

**Corrective Action**

1. Push the Emergency Stop and/or DC Circuit Breaker **ON** if tripped.
2. Try the control switch on the generator set (local) if there is no response at a remote control switch, and vice versa.
3. If none of the control switches works, service as necessary by cleaning and tightening battery connections, recharging or replacing the battery or replacing damaged battery cables.

**THE STARTER ENGAGES AND DISENGAGES****Possible Cause**

Low cranking voltage

**Corrective Action**

1. De-energize the PTO clutch, if so equipped.
2. Service as necessary by cleaning and tightening battery connections, recharging or replacing the battery or replacing damaged battery cables.
3. Service the starter.

**THE STARTING BATTERIES DO NOT MAINTAIN A CHARGE****Possible Cause**

Marginal battery, battery connections or charging system

**Corrective Action**

1. Service as necessary by cleaning and tightening battery connections, recharging or replacing the battery or replacing damaged battery cables.
2. Check the V-belt that drives the charging alternator and service as necessary.
3. Check for and disconnect parasitic battery loads.
4. Service the battery charging alternator.

**NO AC POWER WHEN GENERATOR SET IS RUNNING****Possible Cause**

A Circuit Breaker is OFF, tripped or malfunctioning or the generator is not connected properly

**Corrective Action**

1. Reset, turn **ON** or repair the generator set circuit breaker, as necessary.
2. Reset, turn **ON** or repair any other circuit breaker in the AC power supply system, as necessary.

3. Reconnect the generator properly for the application.

### **CODE NO. 1—HIGH ENGINE TEMPERATURE**

#### **Possible Cause**

Engine coolant temperature exceeds design limit

#### **Corrective Action**

1. Check for and clean a blocked sea water strainer. If above the water line, fill the strainer with water to assist priming.
2. Check engine coolant level and add coolant as necessary.
3. Check for kinked or leaking hoses and reconnect, reroute or replace.
4. Check the V-belt that drives the coolant pump and service as necessary.
5. Inspect the siphon break for proper operation.
6. Test coolant sender **E2** and replace if necessary.
7. Disconnect connector **P1** (black) from the generator set controller and check for electrical continuity between **Pin 9** and the ring terminal on sender **E2**. If it is an isolated-ground sender, also check for electrical continuity between **E2-2** and **B**-(ground). Repair wiring and connectors as necessary.
8. Check for a worn raw water impeller and replace as necessary.
9. Clean the heat exchanger.
10. Check the bottom of the hull for any blockage at the through-hull fitting.
11. Replace the coolant thermostat, which might not be opening fully.
12. Drain and clean the coolant system to remove coolant passage fouling.

### **CODE NO. 2—LOW OIL PRESSURE**

#### **Possible Cause**

Low oil pressure

#### **Corrective Action**

1. Check the engine oil level and add or drain oil as necessary. Repair any oil leaks.
2. If loose, tighten the ring terminal on oil pressure sender **E1**.
3. Check electrical resistance through sender **E1**. Replace the sender if resistance is not between 227 and 257 ohms (0 psi) when the engine is stopped.
4. Disconnect connector **P1** (black) from the generator set controller and check for electrical continuity between **Pin 10** and the ring terminal on sender **E1**. If it is an isolated-ground sender, also check for electrical continuity between **E1-2** and **B**-(ground). Repair wiring and connectors as necessary.
5. Service the engine lubricating system.

---

**CODE NO. 3—SERVICE CHECK****Possible Cause**

A fault with a 2-Digit Fault Code Number occurred

**Corrective Action**

Check the 2-Digit fault code by *Pushing* and *Releasing Stop*. The 2-Digit fault will be one of the following in this table. (Does not apply to Digital Display.)

**CODE NO. 4—OVERCRANK****Possible Cause**

Cranking time exceeded 20 to 60 seconds, depending on engine temperature

**Corrective Action**

1. De-energize the PTO clutch, if so equipped.
  2. Check fuel level and refill as necessary. (Note: The generator set fuel pickups are probably higher than the propulsion engine fuel pickups.)
  3. Open any closed fuel supply and return valves.
  4. Prime the engine fuel system for at least 30 seconds.
  5. Service as necessary by cleaning and tightening battery connections, recharging or replacing the battery or replacing damaged battery cables.
  6. Remove combustion air or exhaust system blockages.
  7. Check all fuel fittings for fuel and air leaks and tighten as necessary.
  8. Replace fuel filters.
  9. Check for contaminated fuel by connecting to a source of known fuel quality.
  10. Change the engine oil to oil of the proper viscosity for the ambient temperature. High oil viscosity can slow down cranking speed.
  11. Conduct a fuel pump test and replace if necessary.
  12. Inspect and service the glow plugs as follows:
    - a. If loose, tighten the glow plug terminals.
    - b. Check for **B+** at the glow plug terminals during cranking. If there is no **B+**, remove glow plug relay K3 from its socket in the control box, test for proper operation and replace if necessary. Also check for **B+** at relay socket terminal 30, for continuity between terminal 87 and the glow plugs and for continuity between terminal 86 and **B-** (ground). Clean and tighten connections and replace wiring as necessary.
    - c. Check for **B+** at relay socket terminal 85 while cranking. If there is no **B+**, disconnect connector P1 (black) from the generator set controller and check for a missing, bent or corroded pin (P1-1) and faulty wire and repair as necessary. If the wire and connections are good, replace the generator set controller.
    - d. Remove the glow plug bus bar and check for electrical continuity between each glow plug terminal and **B-** (ground). Replace any open glow plug.
  13. Check for proper operation of the governor actuator and replace if necessary.
-

14. Check compression and cylinder leak down and service a worn engine.
15. Service the fuel injectors.
16. Check for proper operation of the internal governor mechanism.

#### **CODE NO. 5—WARNING SHUTDOWN DUE TO VESSEL CO**

##### **Possible Cause**

Dangerous levels of Carbon Monoxide in Vessel

##### **Corrective Action**

Get everyone out into fresh air immediately and seek medical attention.

#### **CODE NO. 7—LOSS OF RAW WATER FLOW**

##### **Possible Cause**

Low raw water pressure in heat exchanger

##### **Corrective Action**

1. Open the sea cock.
2. Check for a blocked sea water strainer and clean it out. If above the water line, fill the strainer with water to assist priming.
3. Check for kinked or leaking hoses and reconnect, reroute or replace.
4. If loose, reconnect terminals **S6+** and **S6-** to raw water flow switch **S6**.
5. Test raw water flow switch **S6** and replace as necessary.
6. Check for a worn raw water impeller and replace as necessary.
7. Check the bottom of the hull for any blockage at the through-hull fitting.
8. Disconnect connector **P1** (black) from generator set controller and check continuity between **Pin 8** and terminal **S6+** and between terminal **S6-** and **B-** (ground). Repair wiring and connectors as necessary.

#### **CODE NO. 12—HIGH AC VOLTAGE**

##### **Possible Cause**

After voltage regulation was enabled Output Voltage jumped to more than 125% of rated for 75 milliseconds or to more than 115% of rated for 3 seconds

##### **Corrective Action**

1. Check for a tripped generator set circuit breaker, reset if necessary, and run with fewer loads. (A breaker tripping under load can cause generator set voltage to overshoot.)
2. Check all fuel fittings and filters for fuel and air leaks and tighten as necessary. (Air bubbles can disrupt generator set frequency/voltage.)
3. Prime the engine fuel system for at least 30 seconds.

4. Push the generator set line circuit breaker **OFF**, start the generator set and measure output voltage. If output voltage is normal, the problem is in the circuits external to the generator set. If there is no voltage, test for grounded or shorted main, field or quadrature windings and service as necessary.

### **CODE NO. 13—LOW AC VOLTAGE**

#### **Possible Cause**

After voltage regulation was enabled Output Voltage fell to less than 90% of rated for 5 seconds

#### **Corrective Action**

1. Push the generator set line circuit breaker OFF and disconnect the PTO, if so equipped. If the generator set now runs and voltage and frequency are normal, reduce the number of electrical and mechanical (PTO) loads.
2. Check the fuel tank and fill as necessary. (Note: The arrangement of pickup tubes in the fuel supply tank probably is such that the generator set will run out of fuel before the propulsion engines.)
3. Check all fuel fittings and filters for fuel and air leaks and tighten as necessary. (Air bubbles can disrupt generator set frequency/voltage.)
4. Replace fuel filters.
5. Push the generator set line circuit breaker **OFF** and de-energize the PTO clutch, if so equipped. If the generator set now runs and voltage and frequency are normal, reduce the number of electrical and mechanical (PTO) loads. If there is no voltage, test for grounded or shorted main, field or quadrature windings and service as necessary.

### **CODE NO. 14—HIGH AC FREQUENCY**

#### **Possible Cause**

After the starter was engaged Frequency jumped to more than 70 Hz for 40 milliseconds or to more than 2% over nominal for 6 seconds

#### **Corrective Action**

1. Check for a tripped generator set circuit breaker, reset if necessary, and run with fewer loads. (A breaker tripping under load can cause generator set frequency to overshoot.)
2. Check all fuel fittings and filters for fuel and air leaks and tighten as necessary. (Air bubbles can disrupt frequency.)
3. Check for proper operation of the governor actuator and replace if necessary.
4. Check for proper operation of the internal governor mechanism.

### **CODE NO. 15—LOW AC FREQUENCY**

#### **Possible Cause**

During normal operation Frequency fell to less than 90% of nominal for more than 8 seconds

**Corrective Action**

1. Push the generator set line circuit breaker OFF and de-energize the PTO clutch, if so equipped. If the generator set now runs, reduce the number of electrical and mechanical (PTO) loads, especially those with high motor starting loads, such as air conditioners.
2. Check the fuel tank and fill as necessary.



**NOTE:** The arrangement of pickup tubes in the fuel supply tank probably is such that the generator set will run out of fuel before the propulsion engines.

3. Prime the engine fuel system for at least 30 seconds.
4. Remove combustion air or exhaust system blockages.
5. Check all fuel fittings for fuel and air leaks and tighten as necessary. (Air bubbles can disrupt frequency.)
6. Replace fuel filters.
7. Check for contaminated fuel by connecting to a source of known fuel quality.
8. Conduct a fuel pump test and replace if necessary.
9. Check for proper operation of the governor actuator and replace if necessary.
10. Check compression and cylinder leak down and service a worn engine.
11. Service the fuel injectors.
12. Check for proper operation of the internal governor mechanism.

**CODE NO. 22—GOVERNOR OVERLOAD****Possible Cause**

Maximum allowable time at full-duty cycle was exceeded

**Corrective Action**

1. Reduce the number of appliances running at the same time, especially those with high motor starting loads such as air conditioners.
2. Check the fuel tank and fill as necessary.



**NOTE:** The arrangement of pickup tubes in the fuel supply tank probably is such that the generator set will run out of fuel before the propulsion engines.

3. Remove combustion air or exhaust system blockages.
4. Check all fuel fittings for fuel and air leaks and tighten as necessary.
5. Replace fuel filters.
6. Check for contaminated fuel by connecting to a source of known fuel quality.
7. Conduct a fuel pump test and replace if necessary.
8. Check for proper operation of the governor actuator and replace if necessary.
9. Check compression and cylinder leak down and service a worn engine.
10. Service the fuel injectors.
11. Check fuel injection timing.

12. Check for proper operation of the internal governor mechanism.

### **CODE NO. 23—FAULTY OIL PRESSURE SENDER**

#### **Possible Cause**

Controller sensed grounded sender

#### **Corrective Action**

1. If loose, tighten the ring terminal on oil pressure sender **E1**. (This fault will occur if a loose ring terminal touches grounded metal.)
2. Disconnect connector **P1** (black) from the generator set controller and check for electrical resistance between **Pin 10** and **B-** (ground). If the resistance is less than 227 ohms (engine stopped):
  - a. Repair wiring as necessary to eliminate the ground path.
  - b. Check electrical resistance through sender **E1**. Replace the sender if resistance is not between 227 and 257 ohms (0 psi) when the engine is stopped.

### **CODE NO. 24—FAULTY TEMPERATURE SENDER**

#### **Possible Cause**

Controller sensed open sender

#### **Corrective Action**

1. If loose, tighten the ring terminal on sender **E2**. If it is an isolated-ground sender, also make sure the flag terminal is connected to terminal **2** on the sender.
2. Disconnect connector **P1** (black) from generator set controller and check continuity between **Pin 9** and ring terminal **E2-1**. If it is an isolated-ground sender, also check continuity between **E2-2** and **B-**(ground). Repair wiring and connectors as necessary.
3. Test sender **E2** and replace as necessary.

### **CODE NO. 27—LOSS OF AC VOLTAGE SENSE**

#### **Possible Cause**

The generator set Controller lost VAC sensing during normal voltage regulation when the field was functioning normally and frequency was at least 40 Hz

#### **Corrective Action**

1. Disconnect connector **P3** (green) from the generator set controller and check continuity between **Pin 11** (S1) and **Pin 12** (S2). If open, check for missing, bent or corroded pins and faulty wiring and repair as necessary.
2. Test and service the generator as necessary.



---

**CODE NO. 29—HIGH BATTERY VOLTAGE****Possible Cause**

During startup the generator set Controller sensed that battery system voltage was greater than 19.2 volts if 12 VDC system or 32.2 volts if 24 volt system

**Corrective Action**

1. Check battery bank connections and reconnect if necessary for 12 volts or 24 volts, depending on generator set model.
2. Select a lower battery booster charge rate (external charging system).

**CODE NO. 32—STARTING FAULT****Possible Cause**

The generator set Controller could not detect cranking speed [quadrature zero crossings] for 3 seconds

**Corrective Action**

1. De-energize the PTO clutch, if so equipped.
2. Have the propulsion engines running while trying to start the generator set. Their charging alternators may be able to maintain a high enough battery terminal voltage to start the generator set.
3. Service as necessary by cleaning and tightening battery connections, recharging or replacing the battery or replacing damaged battery cables.
4. Change the engine oil to oil of the proper viscosity for the ambient temperature. High oil viscosity can slow down cranking speed.
5. Check for proper operation of starter relay **K4** and replace if necessary.
6. Disconnect connector **P3** (green) from the generator set controller and measure resistance between **Pin 10** and **K4-86** and between **K4-85** and **CB2-2**. If either lead is open, check for a missing, bent or corroded pin or faulty wiring and repair as necessary.
7. Service the starter motor.
8. Service the engine if the crankshaft is unusually hard to rotate manually.

**CODE NO. 35—CONTROL CARD FAILURE-EE****Possible Cause**

During startup the generator set Controller detected a EE memory error

**Corrective Action**

See an authorized Cummins Onan service representative. Replace the generator set controller.

**CODE NO. 36—UNKNOWN SHUTDOWN****Possible Cause**

The generator set Controller declared this fault because engine speed fell below 1000 RPM for 0.5 seconds, though not by generator set or engine control action

**Corrective Action**

1. Check for mechanical damage and service as necessary.
2. Push the generator set line circuit breaker **OFF** and disconnect the PTO, if so equipped. If the generator set now runs, reduce the number of electrical and mechanical (PTO) loads.
3. Check fuel level and refill as necessary. (Note: The generator set fuel pickups are probably higher than the propulsion engine fuel pickups.)
4. Prime the engine fuel system for at least 30 seconds.
5. Remove combustion air or exhaust system blockages.
6. Check all fuel fittings for fuel and air leaks and tighten as necessary.
7. Replace fuel filters.
8. Conduct a fuel pump test and replace if necessary.
9. Disconnect connector **P1** (black) from the generator set controller and measure resistance between **Pin 5** and **A12+** and between **Pin 4** and **A12-**. If either lead is open, check for a missing, bent or corroded pin or faulty wiring and repair as necessary.
10. Check for proper operation of the governor actuator and replace if necessary.
11. Check for a malfunctioning exciter or rotor or open or grounded quadrature circuit, and service as necessary.
12. Service the fuel injectors.
13. Check for proper operation of the internal governor mechanism.
14. Check compression and cylinder leak down and service a worn engine.

**CODE NO. 37—INVALID GENERATOR SET CONFIGURATION****Possible Cause**

The generator set Controller is not configured properly for the generator set

**Corrective Action**

1. Make sure the ends of the two leads marked CONFIG 1 and CONFIG 2 in the control box are not connected and that they are terminated with insulated connectors.
2. Reconfigure the generator set controller.

**CODE NO. 38—FIELD OVERLOAD****Possible Cause**

High field voltage induced by high rotor temperature or low power factor loads

**Corrective Action**

1. Remove blockages to generator air flow at the front inlet air grill.
2. Reduce the number of appliances running at the same time, especially those with high motor starting loads, such as air conditioners.
3. Have air conditioners and other appliances checked for proper operation. (A locked compressor rotor can cause very low power factor.)
4. Test and service the generator as necessary.

**CODE NO. 43—CONTROL CARD FAILURE-RAM****Possible Cause**

During startup the generator set Controller detected a RAM memory error

**Corrective Action**

See an authorized Cummins Onan service representative. Replace the generator set controller.

**CODE NO. 45—SPEED SENSE LOST****Possible Cause**

After start disconnect the generator set Controller lost speed sense [quadrature zero crossings] for 0.25 seconds

**Corrective Action**

1. Disconnect connector **P3** (green) from the generator set controller and check for open or shorted field (**P3-7** to **P3-8**) and quadrature (**P3-4** to **P3-5**) windings. Service the generator as necessary.
2. Replace the generator set controller.

**CODE NO. 57—OVERPRIME****Possible Cause**

A local or remote control switch was held in the Prime position for more than 5 minutes

**Corrective Action**

1. Check for and remove any object that may be holding any control switch (local or remote) in the prime position.
2. Replace any control switch (S4) in the control system that does not open across terminals **1** and **2** when **Stop** is released.

**CODE NO. 58—HIGH EXHAUST TEMPERATURE****Possible Cause**

Exhaust temperature exceeded design limits due to lack of water delivered to the exhaust/water mixer

**Corrective Action**

1. Check for and reconnect or replace any disconnected, kinked or leaking raw water hoses.
2. Check for and clean a blocked sea water strainer. If above the water line, fill the strainer with water to assist priming.
3. Inspect the siphon break (if provided) for proper operation.
4. If loose, reconnect terminals **S5+** and **S5-** to high exhaust temperature switch **S5**.
5. Disconnect connector **P1** (black) from generator set controller and check continuity between **Pin 11** and terminal **S5+** and between terminal **S5-** and **B**-(ground). Repair wiring and connectors as necessary.
6. Test high exhaust temperature switch **S5** and replace as necessary.
7. Check for a worn raw water impeller and replace as necessary.
8. Clean the heat exchanger.

**CODE NO. 59—LOW COOLANT LEVEL****Possible Cause**

The engine coolant level fell below the optional coolant level sensor

**Corrective Action**

Add coolant as necessary and repair leaks.

**CODE NO. 61—EXTERNAL SHUTDOWN****Possible Cause**

The generator set was shut down by a fire suppression system or other external control

**Corrective Action**

Make all necessary repairs to the generator set and connected equipment and reset the external control which shut down the generator set.

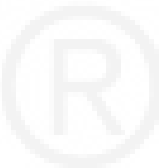

# 8 Specifications

**TABLE 3. MODEL SPECIFICATIONS TABLE**

	6 MDKBJ	7.5 MDKBJ
<b>Frequency</b>	50 Hz	60 Hz
<b>Output Ratings</b>	6 kW/6 kVA	7.5 kW/7.5 kVA

**TABLE 4. GENERATOR SET SPECIFICATIONS TABLE**

	6 MDKBJ	7.5 MDKBJ
<b>Installation Diagrams:</b>		
Outline drawing part number	A029F006	
<b>Size Without Sound Shield: mm (in)</b>		
Dimensions: L x W x H	N/A	
<b>Size With Sound Shield: mm (in)</b>		
Dimensions: L x W x H	664 x 583 x 535 (26.1 x 23 x 21.1)	
<b>Weight Without Sound Shield: kg (lb)</b>		
Dry Weight	N/A	
Wet Weight	N/A	
<b>Weight With Sound Shield: kg (lb)</b>		
Dry Weight	195 (429)	
Wet Weight	200 (442)	
<b>Sound Level With Sound Shield: dB(A) @ 1 Meter</b>		
Sound Level	69	71

**TABLE 5. ALTERNATOR SPECIFICATIONS TABLE**

	6 MDKBJ	7.5 MDKBJ
<b>Alternator Design</b>	Cummins Generator Technology YVB Alternator, 2-Pole Belt Drive. See the Generator Nameplate for Rating.	
<b>Alternator Cooling</b>	Direct drive centrifugal blower fan.	

**TABLE 6. FUEL CONSUMPTION SPECIFICATIONS TABLE**

	6 MDKBJ	7.5 MDKBJ
<b>Fuel Consumption:</b>		
25% Load L/Hr (Gal/Hr)	1.12 (0.30)	1.40 (0.37)

50% Load L/Hr (Gal/Hr)	1.46 (0.39)	1.84 (0.48)
75% Load L/Hr (Gal/Hr)	1.84 (0.48)	2.33 (0.61)
100% Load L/Hr (Gal/Hr)	2.28 (0.60)	2.93 (0.77)

**TABLE 7. ENGINE SPECIFICATIONS TABLE**

	6 MDKBJ	7.5 MDKBJ
<b>Engine Design</b>	Kubota 4-Stroke Cycle, Water Cooled Diesel with Digital Electronic Governing	
<b>Model</b>	D722	
<b>Number of Cylinders</b>	3	
<b>Rated RPM</b>	2400	2900
<b>Engine Power (Max SAE J1349)</b>	10.5 kW	11.3 kW
<b>Bore</b>	67 mm (2.64 in)	
<b>Stroke</b>	68 mm (2.68 in)	
<b>Displacement</b>	0.719 L (43.88 in <sup>3</sup> )	
<b>Compression Ratio</b>	23:1	
<b>Firing Order (Clockwise Rotation)</b>	1-2-3	
<b>Ignition Timing</b>	21° BTDC	
<b>Valve Lash (Cold)</b>	0.145 to 0.185 mm (0.00571 to 0.00728 in)	
<b>Required Combustion Air Flow</b>	0.75 m <sup>3</sup> /min (26.5 cfm)	0.91 m <sup>3</sup> /min (32 cfm)
<b>Heat Rejection to Ambient</b>	31 Kcal/min (124 BTU/min)	39 Kcal/min (154 BTU/min)

**TABLE 8. DC ELECTRICAL SYSTEM SPECIFICATIONS TABLE**

	6 MDKBJ	7.5 MDKBJ
<b>Nominal Battery Voltage (DC)</b>	12 V	
<b>Minimum Battery Capacity</b>	450 CCA @ 32° F (° C)	
<b>Net Battery Charging Alternator Current</b>	3 Amps	

**TABLE 9. LUBRICATION SYSTEM SPECIFICATIONS TABLE**

	6 MDKBJ	7.5 MDKBJ
<b>Engine Oil Capacity</b>	3 L (3.2 qt)	
<b>Engine Oil Drain Connection</b>	3/8 NPT	
<b>Maximum Angularity:</b>		
Continuous	20°	
Intermittent	30°	

**TABLE 10. FUEL SYSTEM SPECIFICATIONS TABLE**

	6 MDKBJ	7.5 MDKBJ
<b>Recommended Fuel Type</b>	Grade 2-D Diesel Fuel: Spec EN 590 or ASTM D975	
<b>Required Fuel Line Size</b>	6.4 mm (1/4 in) I.D.	
<b>Fuel Supply Connection</b>	1/8 NPT female	
<b>Maximum Fuel Pump Lift</b>	1.22 m (4 ft)	

**TABLE 11. COOLING SYSTEM SPECIFICATIONS TABLE**

	6 MDKBJ	7.5 MDKBJ
<b>Recommended Coolant Type</b>	Ethylene Glycol: Spec ASTM D5345 for 50/50 Pre-Diluted Coolant	
<b>Coolant Capacity</b>	3.1 L (3.3 quart)	
<b>Coolant Flow Rate</b>	35 L/min (9.2 Gal/min)	29 L/min (7.7 Gal/min)
<b>Heat Rejection to Coolant</b>	145 Kcal/min (575 BTU/min)	180 Kcal/min (714 BTU/min)
<b>Raw Water Inlet Connection</b>	19.1 mm (3/4 in) I.D. Hose	
<b>Raw Water Flow Rate</b>	15 L/min (4 Gal/min)	19 L/min (5 Gal/min)
<b>Maximum Raw Water Pump Lift</b>	1.22 m (4 ft)	

**TABLE 12. EXHAUST SYSTEM SPECIFICATIONS TABLE**

	6 MDKBJ	7.5 MDKBJ
<b>Wet Exhaust Outlet Connection</b>	50.8 mm (2 in) I.D. Hose	
<b>Maximum Exhaust Back Pressure</b>	55 mm Hg (2.2 in Hg)	65 mm Hg (2.6 in Hg)

This page is intentionally blank.





# 9 Emissions

---

This genset meets the requirements of California's Exhaust Emissions Standards as stated on the nameplate. California users of this genset should be aware that unauthorized modifications or replacement of fuel, exhaust, air intake or speed control system components that affect engine emissions are prohibited. Unauthorized modification, removal or replacement of the engine label is prohibited.

You should carefully review the Operator, Installation and other manuals and information you receive with your genset. If you are unsure that the installation, use, maintenance or service of your genset is authorized, you should seek assistance from an approved Onan dealer.

California genset users may use the table below as an aid in locating information related to the California Air Resources Board requirements for emissions control.

Emissions Warranty Information	The California emissions control warranty statement is located in the same packet of information as this manual when the genset is shipped from the factory.
Engine Fuel Requirements	See the <i>Fuel Recommendations</i> section.
Engine Valve Lash	See the <i>Specifications</i> section.
Engine Injection Timing	See the <i>Specifications</i> section.
Engine Lubricating Oil Requirements	See the <i>Engine Oil Recommendations</i> section.
Engine Adjustments	None.
Engine Emission Control System	The engine emission control system consists of engine design and precision manufacture.





This page is intentionally blank.



# 10 How to Obtain Service

For generator set parts, service, and product information (such as the Service manual), contact the nearest authorized Cummins Onan distributor. You may go to Internet site [www.cumminsonan.com](http://www.cumminsonan.com) for information for contacting our distributors worldwide.

## 10.1 Model Identification

Be ready to provide the generator set model and serial numbers on the nameplate when contacting Cummins Onan for parts, service and product information. The figure below illustrates the nameplate information. Every character in these numbers is significant. (The last character of the model number is the specification letter, which is important for obtaining the right parts.) Record the generator set model and serial numbers on the lines designated in the figure so that they are easy to find when you need them.



**WARNING: Improper service or replacement of parts can lead to severe personal injury or death and to damage to equipment and property. Service personnel must be qualified to perform electrical and mechanical service.**

IMPORTANT ENGINE INFORMATION					
	CUMMINS POWER GENERATION 1400 73rd Ave. NE Minneapolis, MN 55432				
Model: <input type="text"/>	Spec: <input type="checkbox"/>	Made in U.S.A.			
S/N: <input type="text"/>	KVA	Pf:	KW:	PH:	RPM:
	50 Hz: <input type="text"/>	<input type="text"/>	<input type="text"/>	<input type="text"/>	<input type="text"/>
	60 Hz: <input type="text"/>	<input type="text"/>	<input type="text"/>	<input type="text"/>	<input type="text"/>
As Manufactured:					
Freq: <input type="text"/>	AC Volts: <input type="text"/>		Amps: <input type="text"/>		
Options: <input type="text"/>	Fuel: <input type="text"/>	Bat: <input type="text"/>			
	Software Cfg: <input type="text"/>				
	Wire Diagram: <input type="text"/>				
Insulation - NEMA Class <input type="text"/> Ambient 40°C					
REFER TO OPERATOR'S MANUAL FOR MAINTENANCE SPECIFICATIONS AND ADJUSTMENTS.					
99-2495 <input type="checkbox"/>					

FIGURE 14. NAMEPLATE

## 10.2 In North America

Call 1-800-888-6626 for the nearest Cummins Onan distributor in the United States or Canada. Press 1 (OPTION 1) to be automatically connected.

---

If you are unable to contact a distributor using the automated service, consult the Yellow Pages. Typically, our distributors are listed under:

GENERATORS - ELECTRIC

### **10.3 Outside North America**

Call Cummins Power Generation at 1-763-574-5000 from 7:30 AM to 4:00 PM (Central Standard Time), Monday through Friday, or fax 1-763-528-7229.

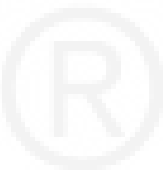





This page is intentionally blank.





## Cummins **Onan**

Cummins Power Generation

1400 73rd Ave. NE

Minneapolis, MN 55432 USA

Phone 1 763 574 5000

Toll-free 1 800 888 6626

Fax 1 763 574 5298

Copyright © 2010 Cummins Power Generation, Inc. All rights reserved.

Cummins, Onan, the "C" logo, and "Performance you rely on." are trademarks of Cummins Inc.